

rward  
NG

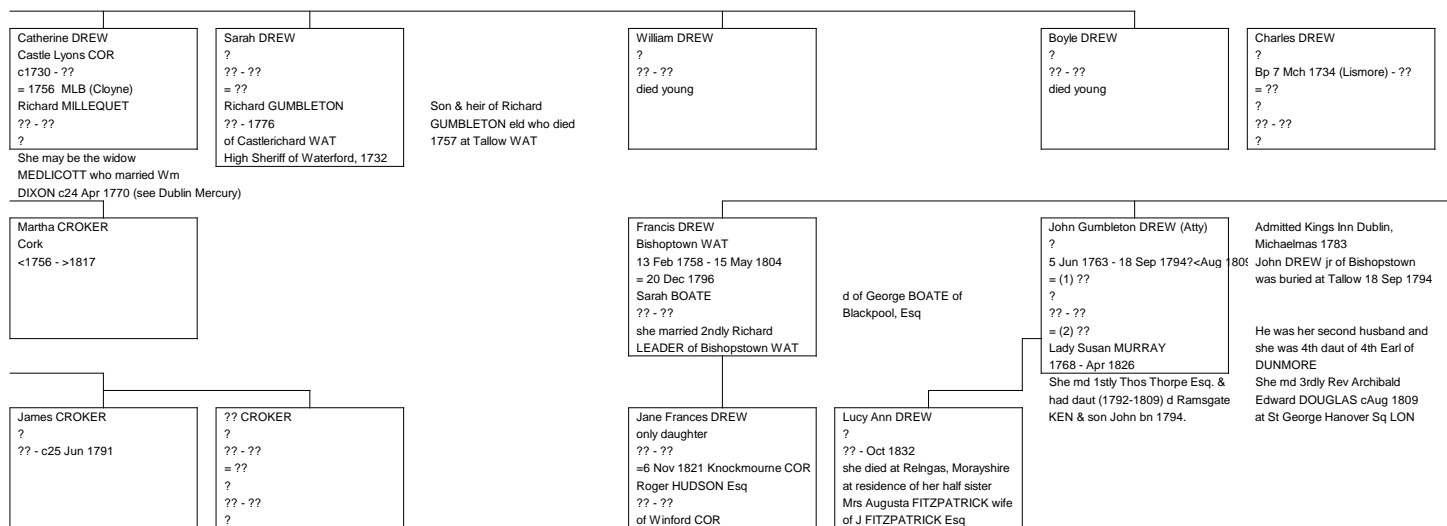

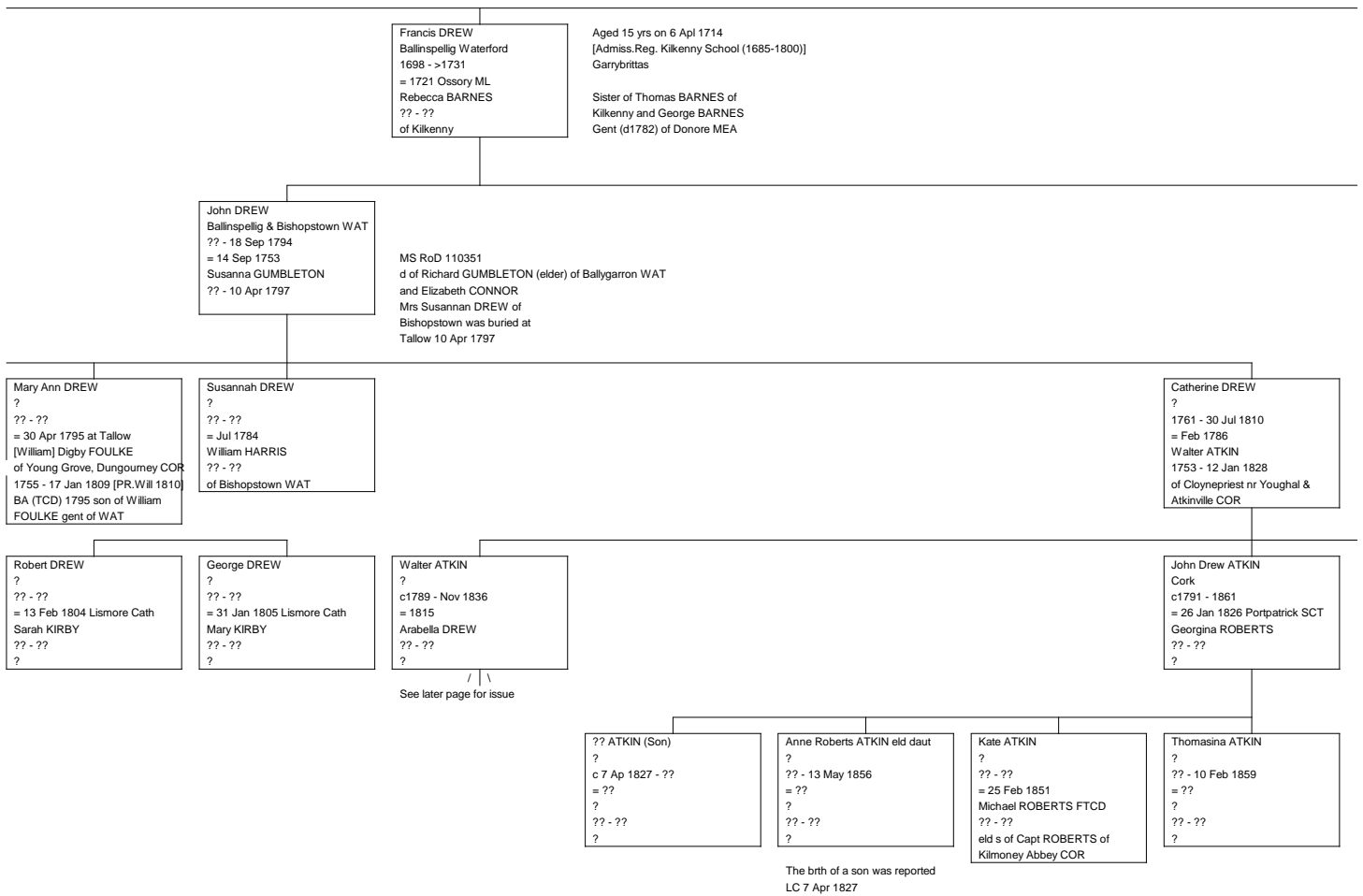

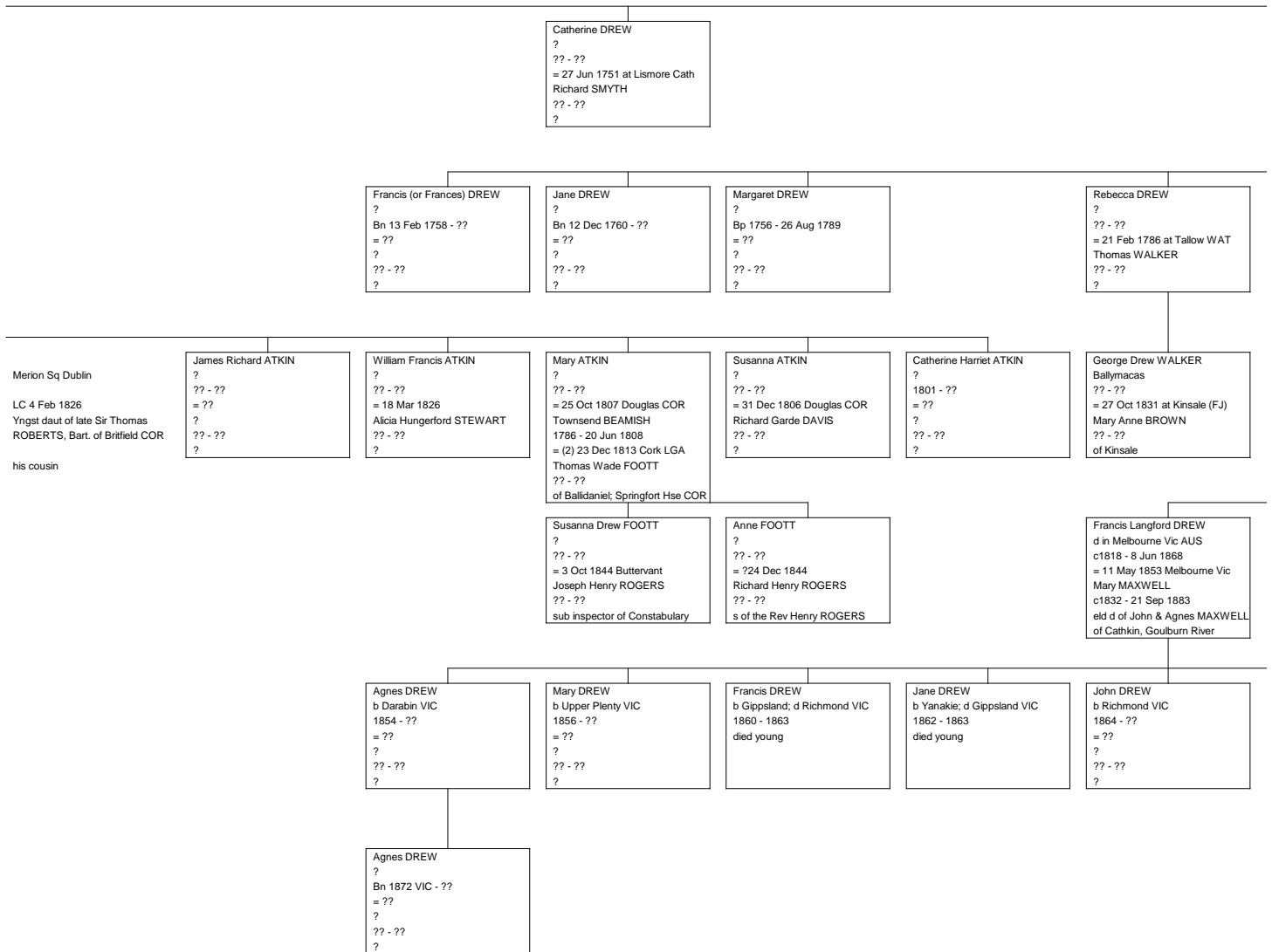

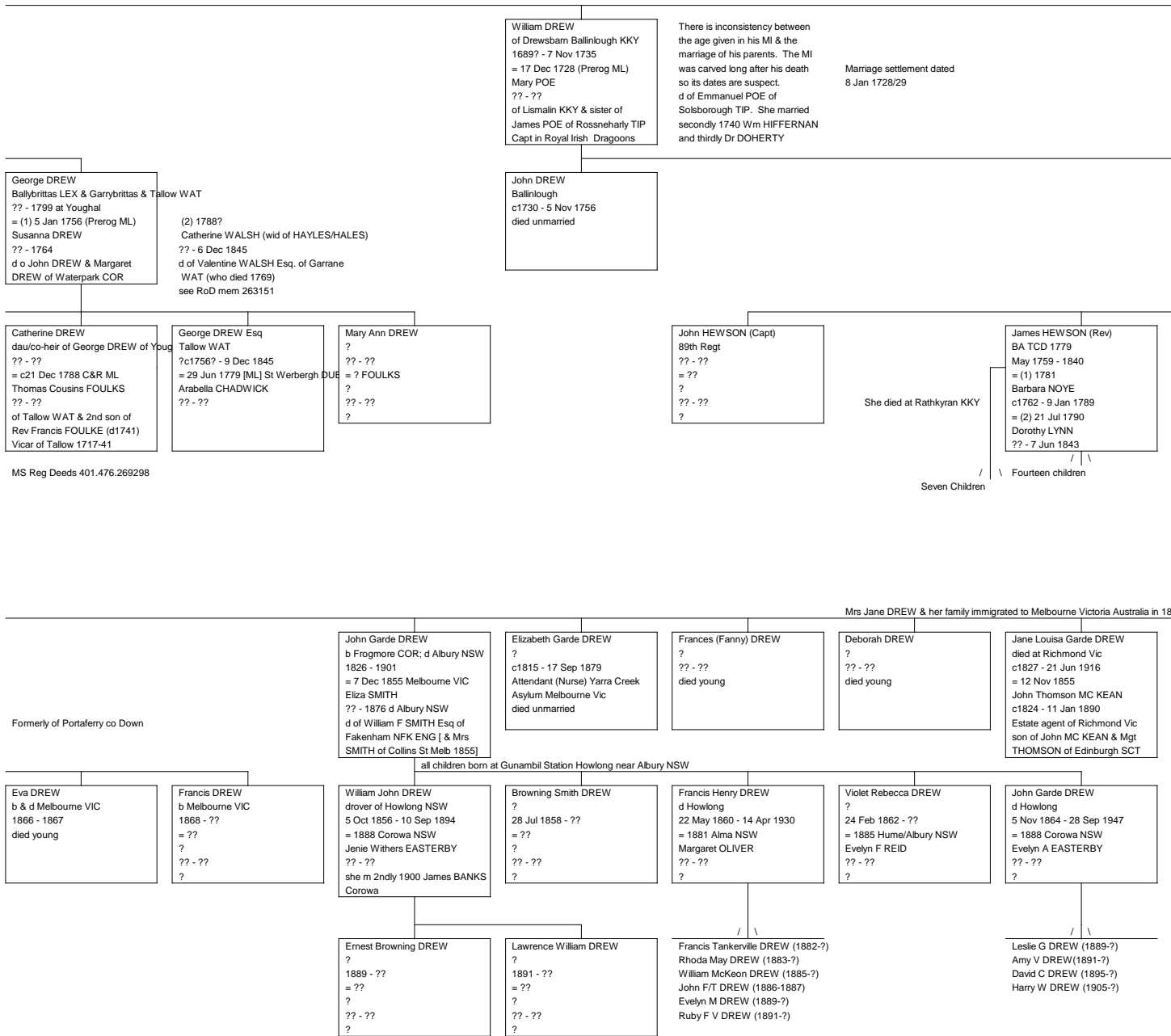

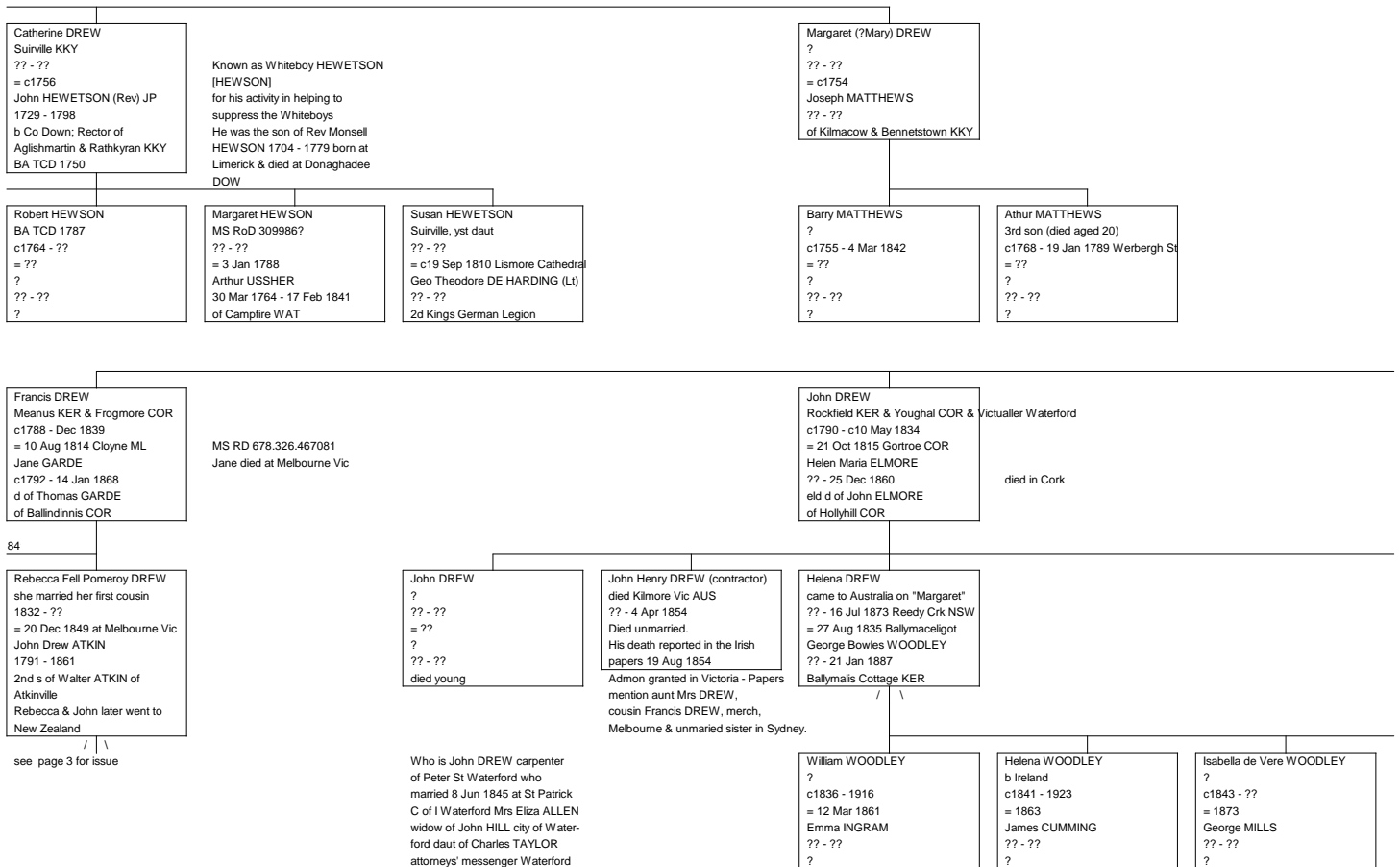

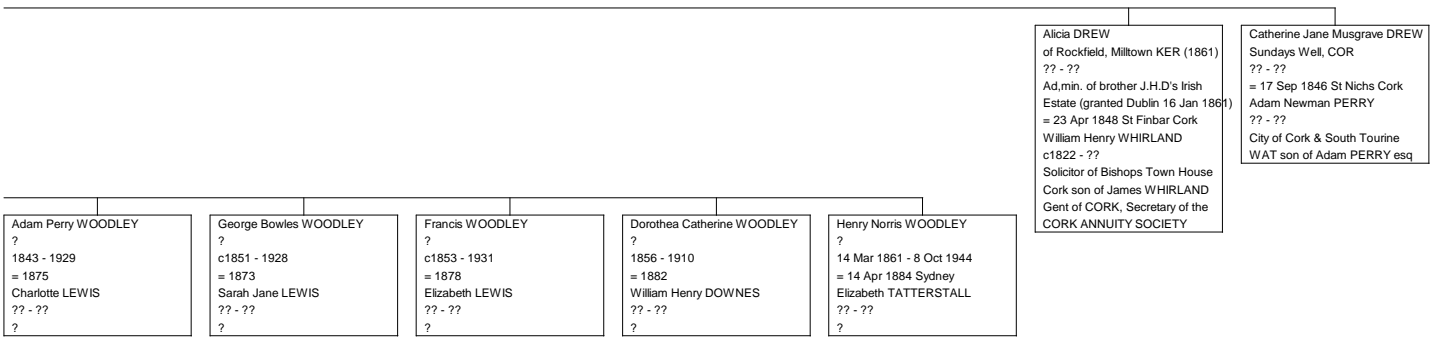

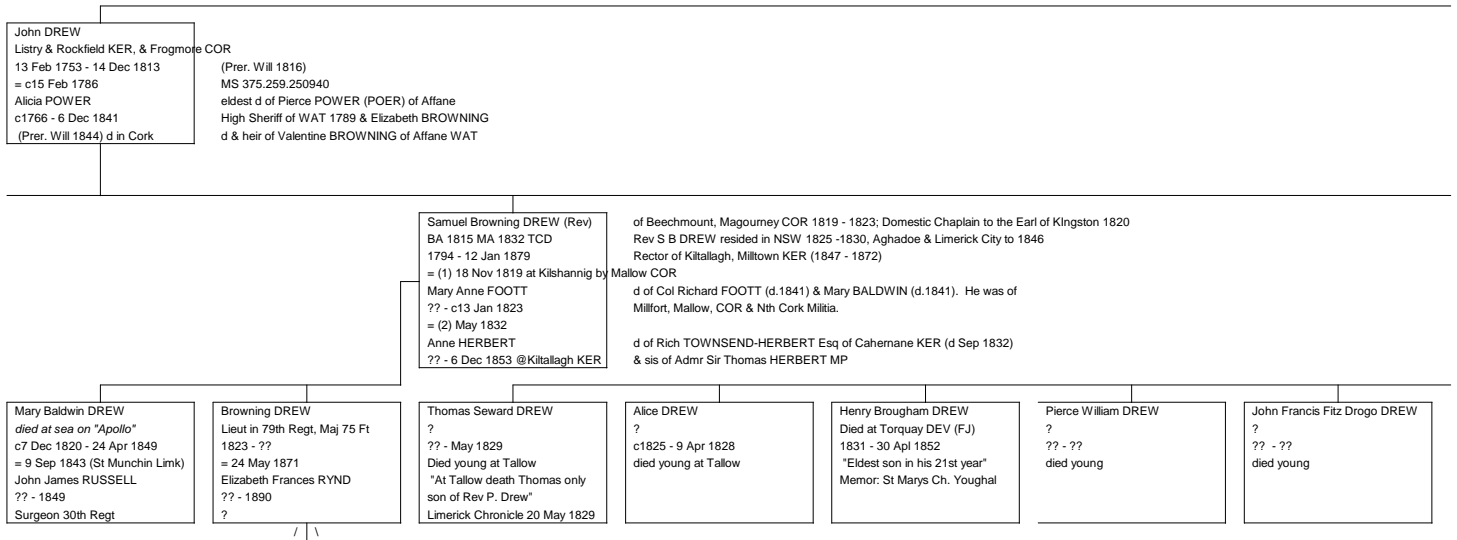



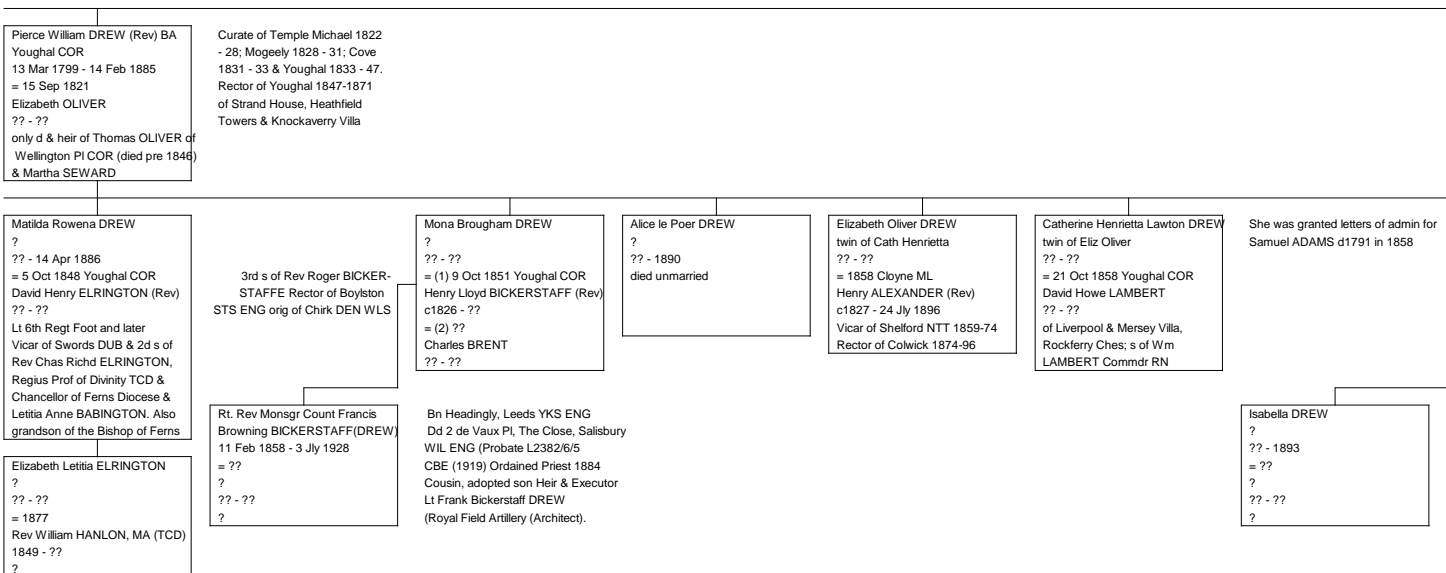

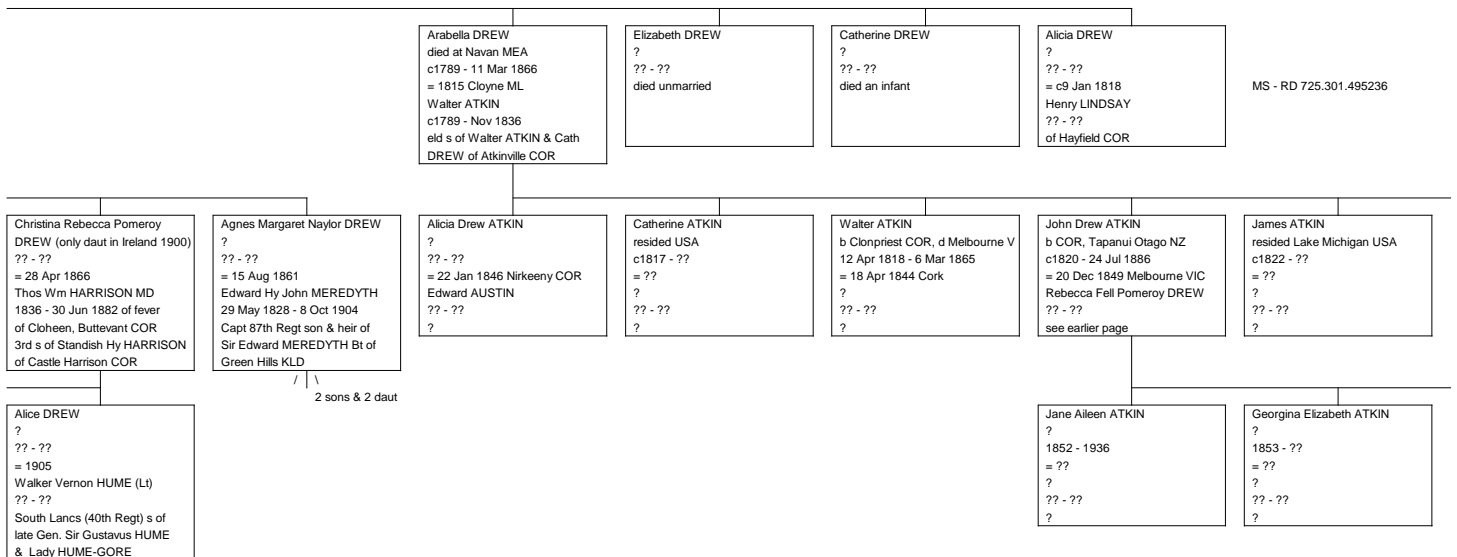

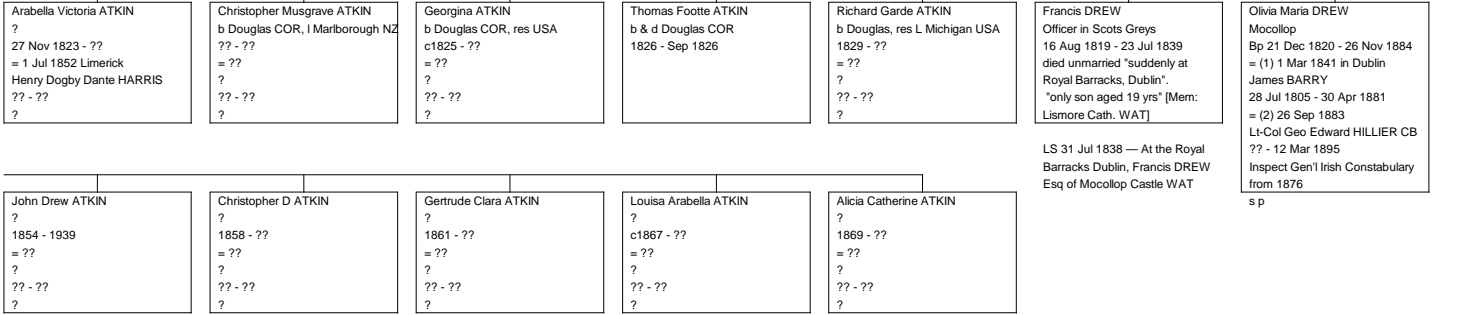
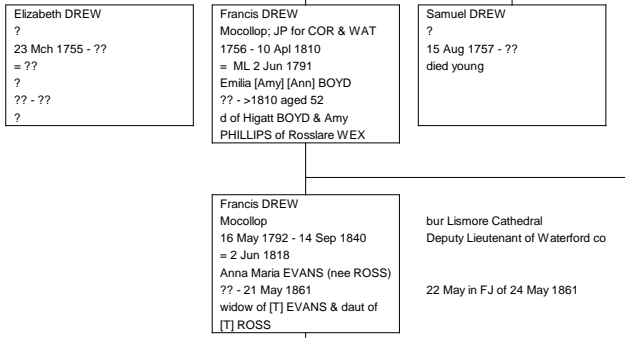
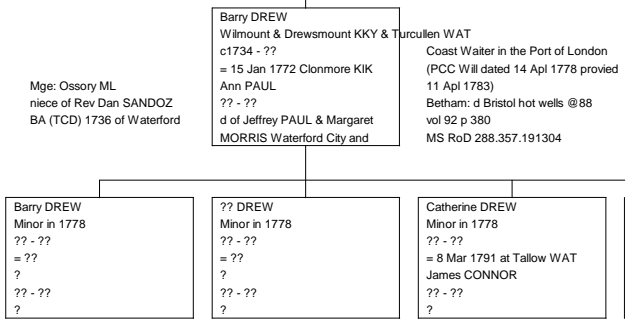

Barry DREW of Drewsmount KKY  
d at Bath c April 1822 @88

James DREW  
?  
?? - <1761  
= ??  
? CONNOR  
?? - ??  
?

From  
*Finn's Leinster Journal*  
11 Apr 1770 - Died Banbury Oxford  
England James DREW Esq a  
gentleman with a large estate  
in this Kingdom(Ireland)

Mary Ann DREW  
Minor in 1778  
?? - ??  
= ??  
?  
?? - ??  
?

William DREW  
?  
24 Feb 1760 - 3 Oct 1801  
died unmarried

Margaret DREW  
?  
1796 - 15 Apr 1797

Tankerville Chamberlain DREW  
Lt 45th Reg of Foot: Cove COR  
1795 - 15 Jun 1843  
= 15 Aug 1822 Cloyne ML  
Jane ELMORE  
c1801 - 13 Oct 1881  
of Dublin in 1852  
d of John ELMORE

?? DREW (son)  
Died young ?  
c 19 Jun 1824 - ?? LC  
= ??  
?  
?? - ??  
?

Helen DREW  
?  
14 Aug 1825 - ??  
= 17 Sep 1851  
Wm Th Fitzherbert Mackenzie INGALL  
?? - ??  
of the Stock Exchange London

**Monumental Inscriptions of Swanscombe Church,  
Noted by Leland L. Duncan 4 June 1922**  
Tankerville Drew INGALL born 19 April 1857, died 23 July 1858.  
Helen Maria Ingall born 2 January 1860 died 28 February 1862.  
Cedric Drew Ingall born 7 July 1867, died 9 July 1867.  
Jane DREW grandmother of above died 13 October 1881 aged 80 year

of Ballyclough & YKS  
High Sheriff of Cork 1841  
eld son of Maj-Gen Henry Green  
BARRY of Ballyclough COR &  
bro of Sir Redmond BARRY  
KCMG CB Chancellor of Uni of  
Melbourne 1853 - 80

Godefroi Drew INGALL  
Eng CRB Lambeth 1d 322  
Sep Q 1852 - ??  
= 1880 Marylebone 1a \*3  
?  
?? - ??  
?

Tankerville Drew INGALL  
Lambeth 1d 368  
19 Apr 1857 - 23 Jul 1858  
died young

Helen Maria INGALL  
?  
2 Jan 1860 - 28 Feb 1862  
died young

Gundulph Drew INGALL  
Dartford 2a 280  
Mar Q 1862 - ??  
= 1900 CRM Lambeth 1d 851  
?  
?? - ??  
?

Cedric Drew INGALL  
CRD 1867 Dartford 2a 178  
7 Jul 1867 - 9 Jul 1867  
died young

Barry Drew INGALL  
CRB Dartford 2a 486  
1883 - ??  
= ??  
?  
?? - ??  
?

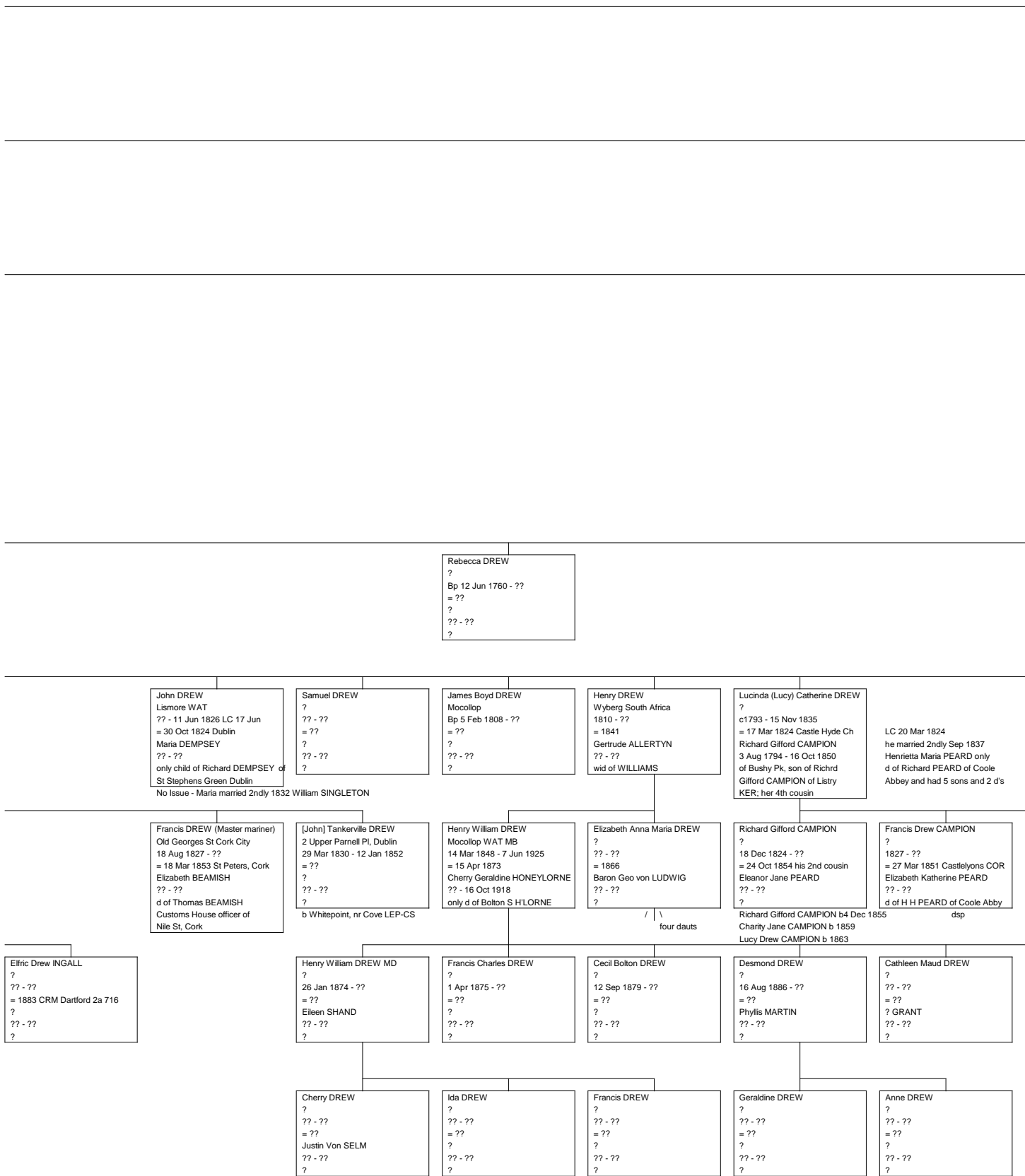

Issue: Justine Von Selm

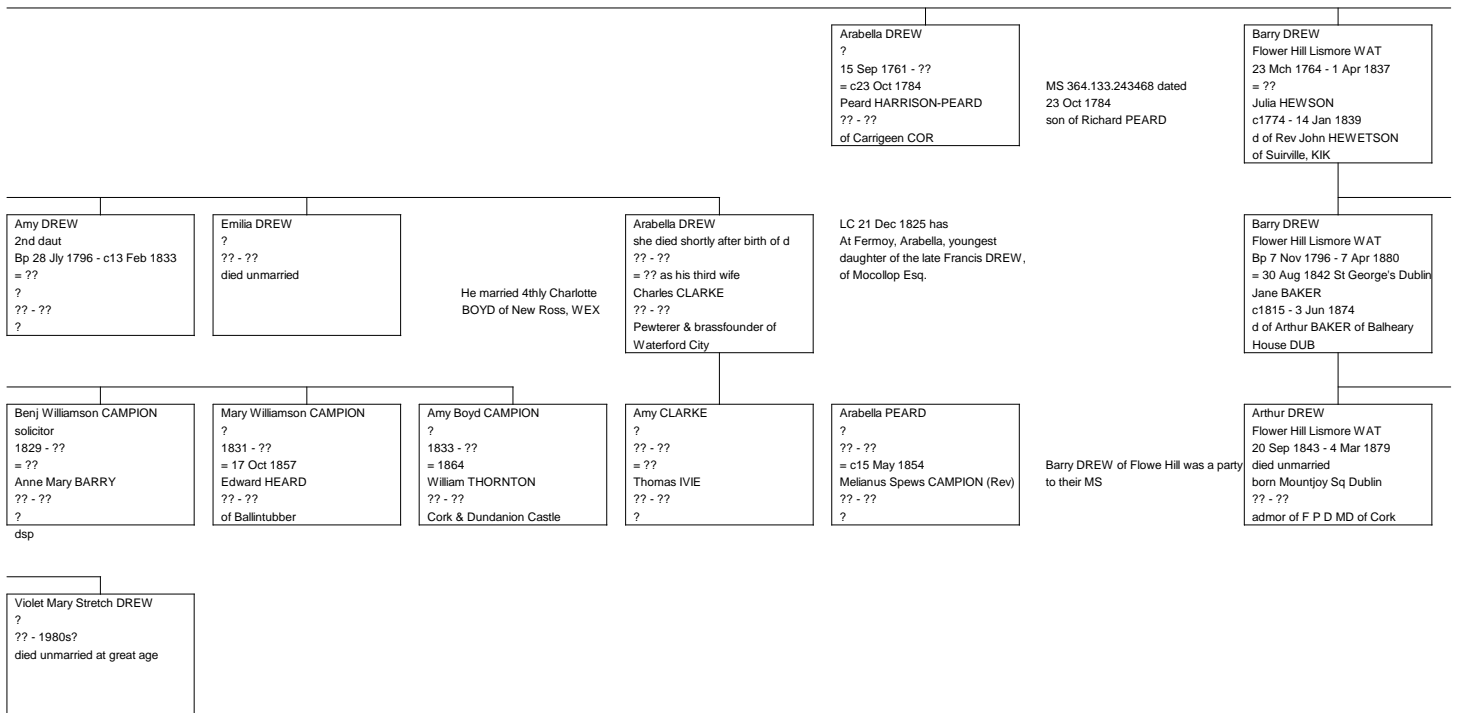

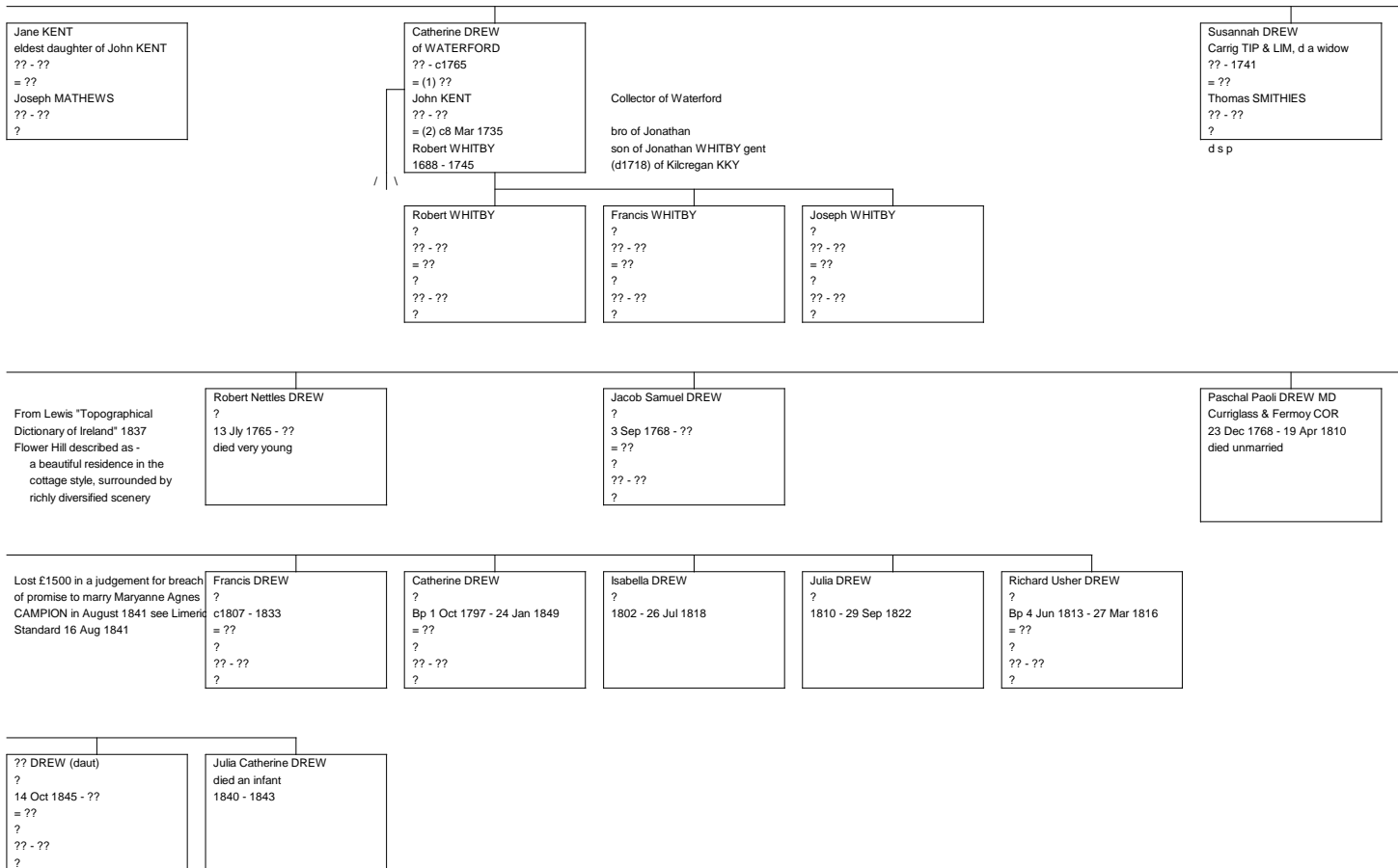

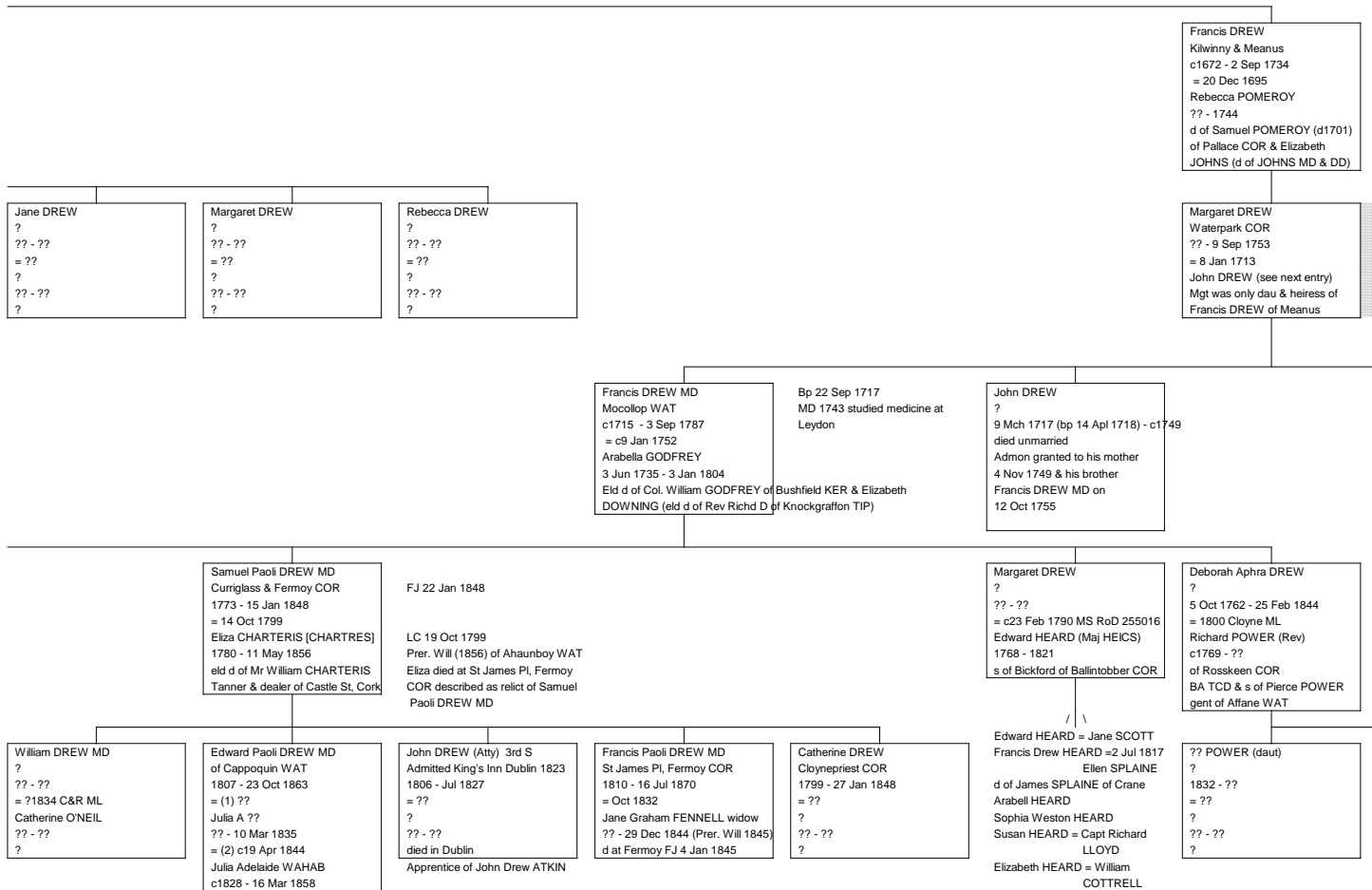



Aged 18 served as Volunteer in King William's Army at Battle of Aughrim (Jul 1691) & at sieges of Athlone, Galway & Limerick.  
Buried at Castle Island Church KER  
Admon to Widow Rebecca 10 Jun 1735.

Mentioned in her father's will 1701

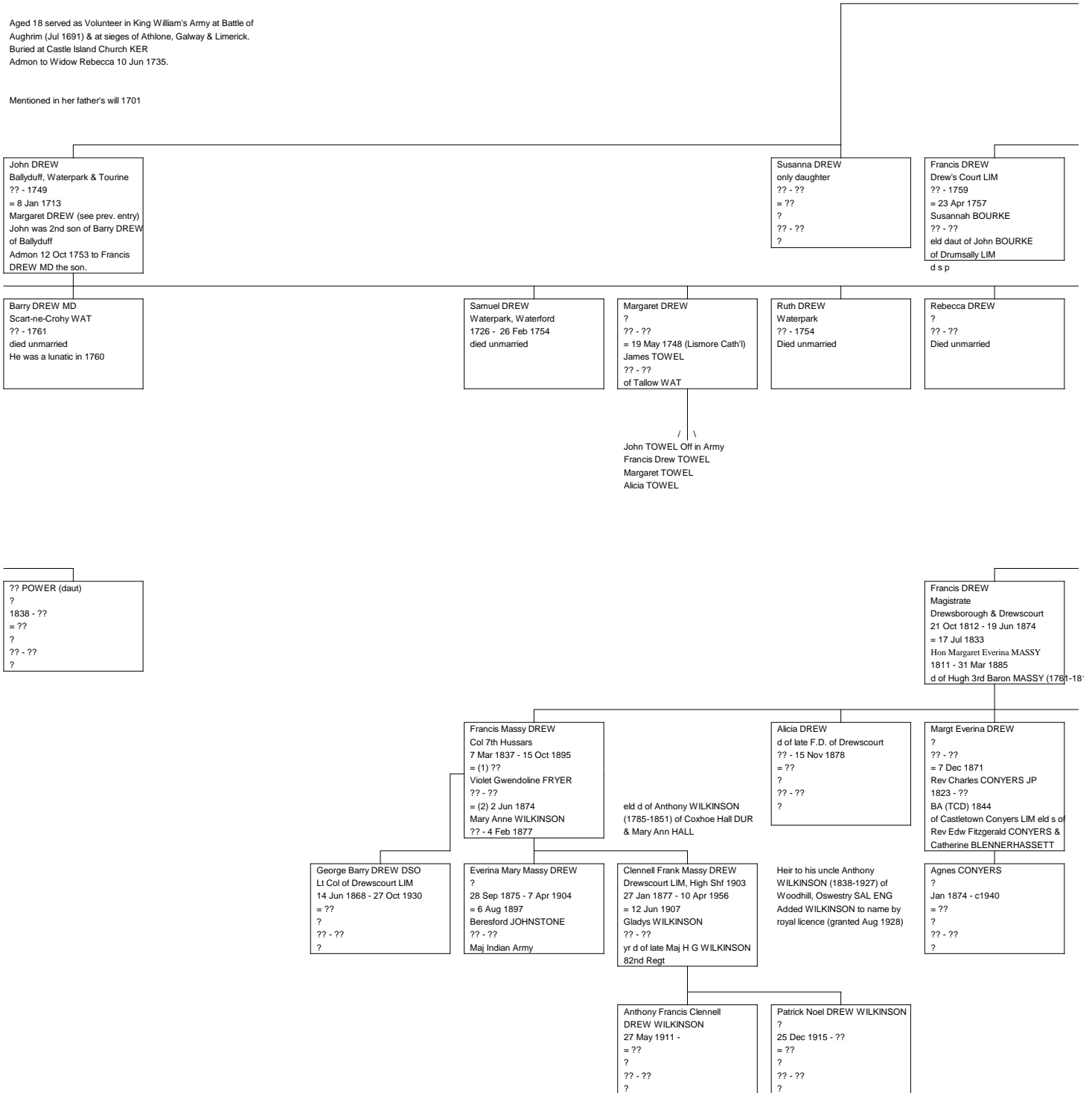



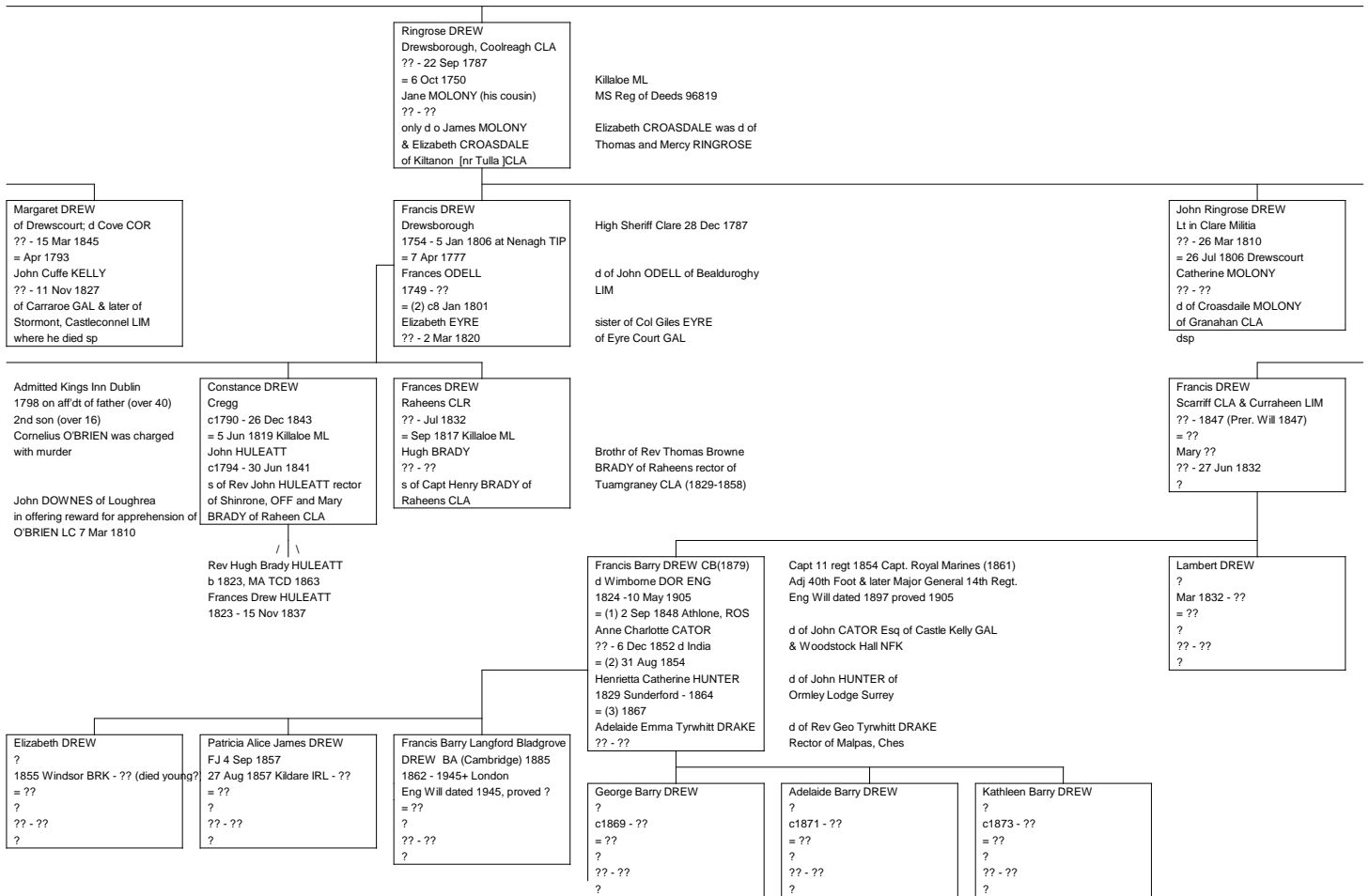

Mary DREW  
 eid daut by first wife  
 ?? - ??  
 = ??  
 William LANGFORD  
 ?? - ??  
 Gurteengary LIM

William LANGFORD  
 Garden Field Limerick  
 ?? - c1719  
 = 1703  
 Gertrude ST LEGER  
 ?? - 1734  
 d of John St LEGER of Doneraile  
 COR & sis of 1st Vct DONERAILE

Attorney Exchequer  
 Admitted Kings Inn Dublin  
 Dec 1779  
 Lt in Clare regt of militia

Lambert DREW  
 Scarriff CLA  
 1758 - 10 Jul 1798  
 = 27 Jan 1785 Killaloe ML  
 Elizabeth BENN  
 ?? - 3 Jul 1834  
 yst d of John BENN  
 Raheen CLA

Lambert was the owner of a  
 mill and baking establishment  
 in Limerick city from 1789  
 LC 27 Jan 1785  
 fortune of £2000

Margaret DREW  
 ?  
 ?? - ??  
 = 28 Aug 1772  
 Maurice ANNESLEY  
 ?? - ??  
 Esq of Waterpark CLA s of  
 Rev Maurice ANNESLEY of  
 Waterpark (1708-1766)

LC 6 Jan 1774 -Births At Drewscourt  
 the wife of Mr Francis ANNESLY,  
 of a daughter, to the great joy of the  
 family

Lim Herald 2 Jul 1832  
 Wednesday last, at Curraheen, in this  
 in the prime of life, Mary, wife of  
 Francis DREW Esq

Eliza DREW  
 Scarriff & Limerick city  
 ?? - 23 Dec 1830  
 = 3 Apr 1809  
 Stephen Byrum GOGGIN  
 ?? - 4 Feb 1831  
 Printer & bookseller Limerick city  
 s of Michael GOGGIN of  
 Limerick city

freeman of Limerick 15 Mar 1813  
 His brother, William, was also freeman

Ringrose DREW  
 eldest son see advert LC Feb 1799  
 1786 - ??  
 = ??  
 ?  
 ?? - ??  
 ?

John Benn DREW  
 ?  
 ?? - ??  
 = ??  
 ?  
 ?? - ??  
 ?

Maurice ANNESLEY  
 ?  
 ?? - ??  
 = ??  
 ?  
 ?? - ??  
 ?

Stephen GOGGIN  
 Limerick City  
 c1810 - ??  
 = ??  
 ?  
 ?? - ??  
 ?

Lambert Drew GOGGIN  
 Limerick city  
 c1812 - ??  
 = 9 Jul 1837  
 Eliza RUTLEDGE  
 ?? - ??  
 3rd d of Sid levers RUTLEDGE  
 of Limerick city & grand daut of  
 Capt Wm TAYLOR Esq, 28 Regt

? GOGGIN (daut)  
 ?  
 ?? - ??  
 = ??  
 ?  
 ?? - ??  
 ?

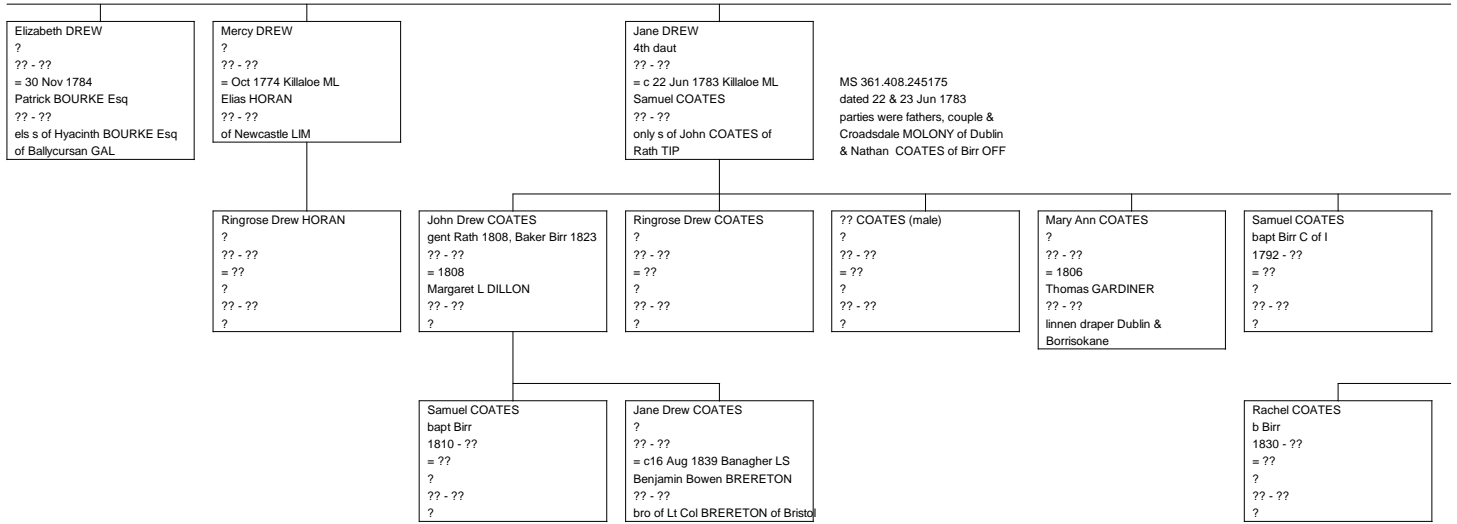

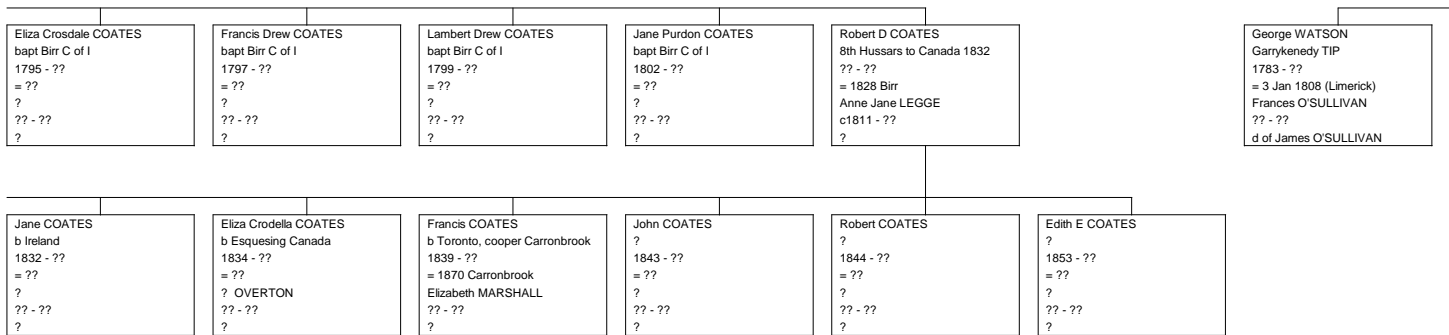

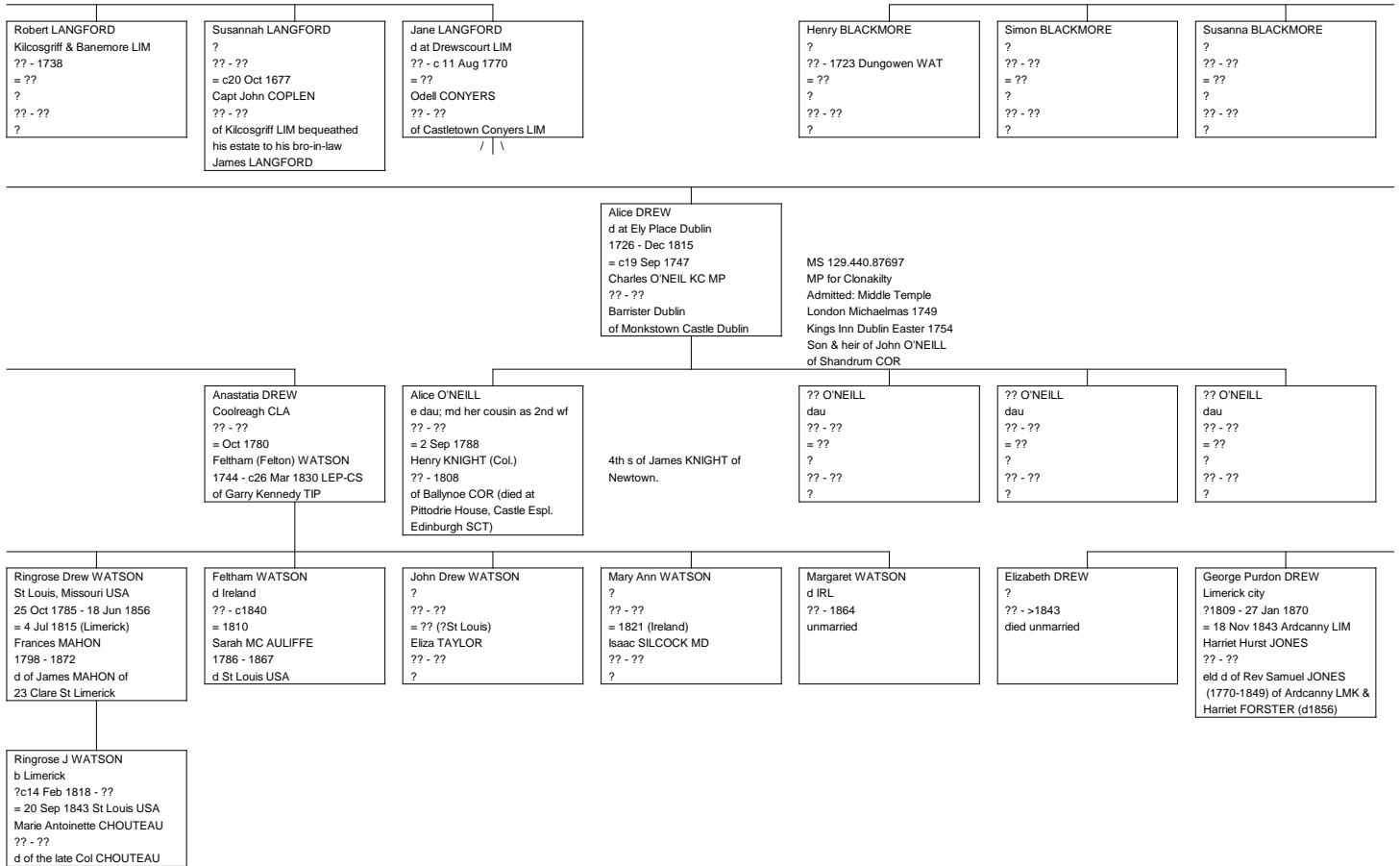

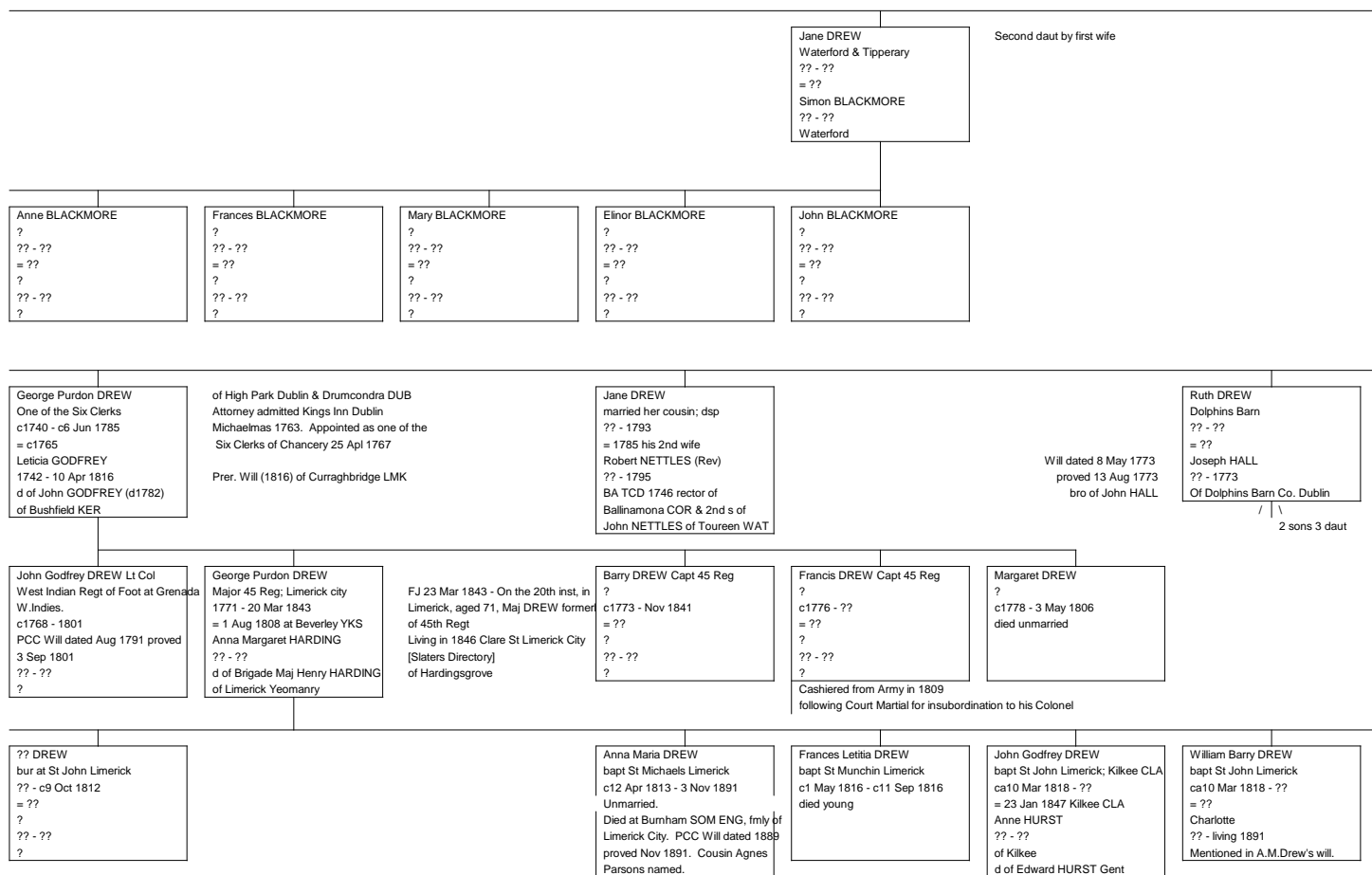



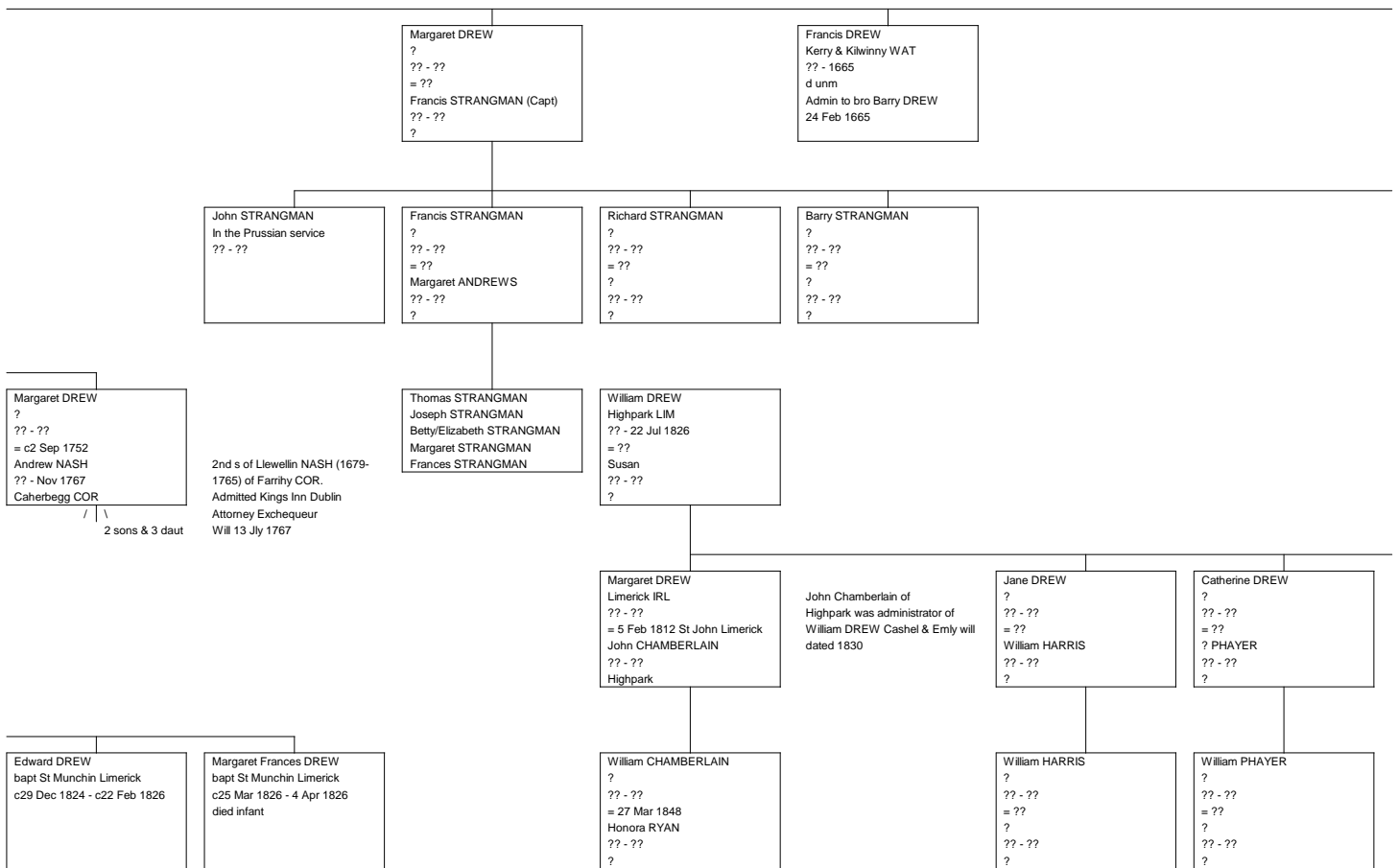

Elizabeth DREW  
?  
?? - ??  
= ??  
? HEAVERNER  
?? - ??  
?

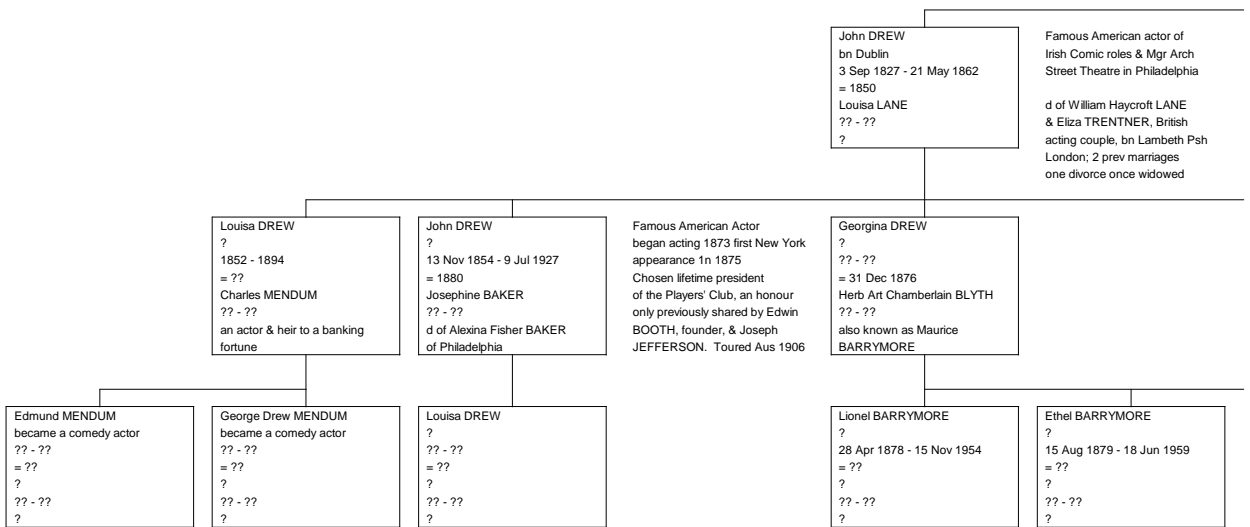

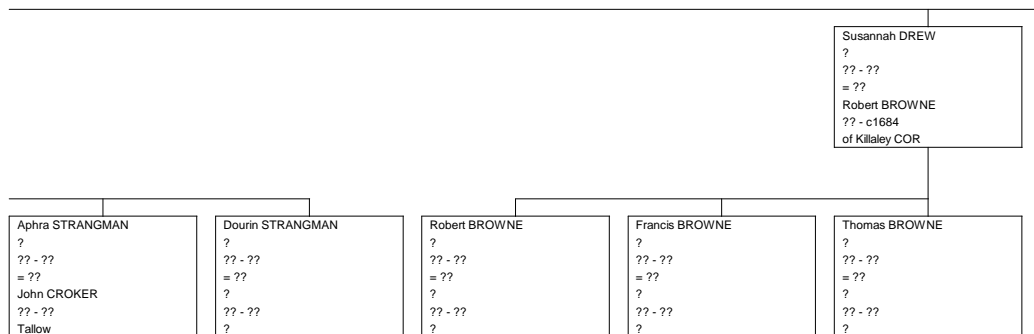

Note: 1

Francis DREW  
Carpenter Mallow La Cork 1782  
?? - ??  
= ??  
?  
?? - ??  
?

Note: 2

Margaret DREW  
yst d of Mr John DREW  
?? - ??  
= 18 Feb 1827  
Mr Daniel O'SHEA  
?? - ??  
?

of South Main St Cork

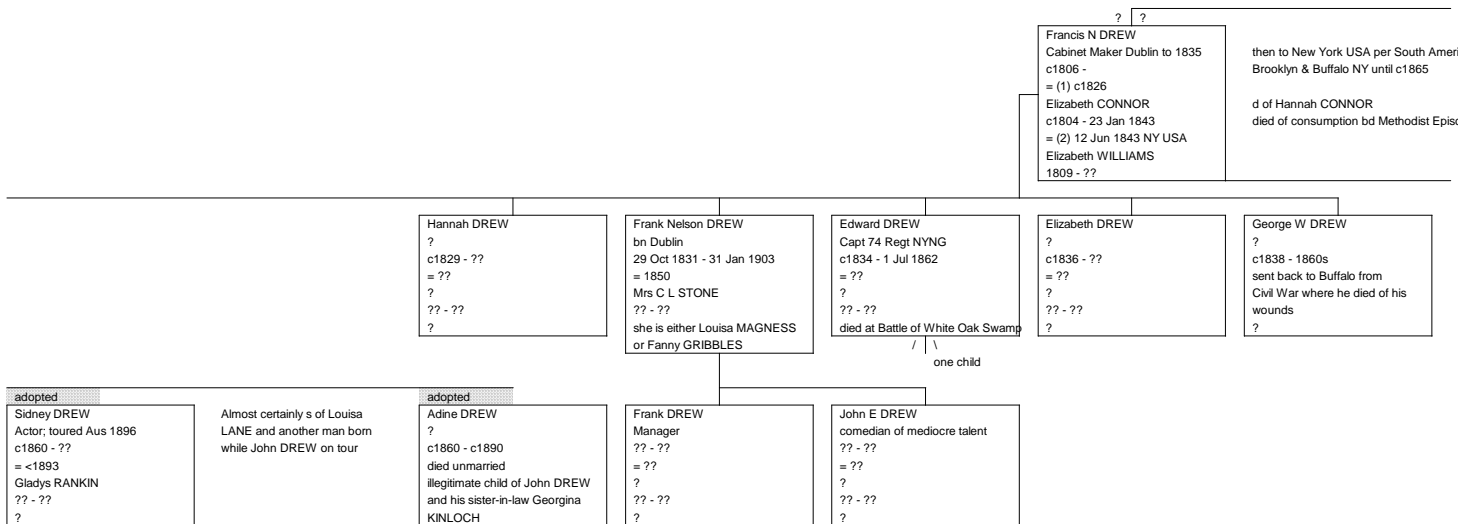

John Sidney BARRYMORE  
?  
5 Feb 1882 - 29 May 1942  
= ??  
?  
?? - ??  
?

Eleanora DREW  
 yngst d of Capt. Francis DREW  
 ?? - 1699  
 = (1) ??  
 Capt Edward BATTY  
 ?? - 1669 Clonmel TIP  
 = (2) c1669  
 John/(Richard) CARLETON Esq  
 ?? - 1682

Eleanora CARLETON widow of  
 Knockmanering TIP died 1685

of Darling Hill TIP died sp.  
 Will dated 1 Nov 1669 proved 1 Jun 1670

of Knockanamara now Darling Hill TIP  
 one of three bros who came to  
 Ireland from Cambridge c1674

John CARLETON  
 High Sheriff of TIP 1717  
 ?? - 1730  
 = ??  
 Jane STRATFORD  
 ?? - ??  
 d of Robert STRATFORD of  
 Baltinglass

Francis CARLETON  
 ?  
 ?? - ??  
 = ??  
 ?  
 ?? - ??  
 ?

|\  
 six sons

Barry DREW  
 ?  
 ?? - ??  
 = ??  
 Elizabeth MOORE  
 ?? - c1774  
 Prer. Will dated 24 Feb 1772 pr. 1774

Sister of Rev. William A. Moore of  
 Waterford

John DREW  
 ?  
 ?? - ??  
 = ??  
 ?  
 ?? - ??  
 ?

Leonard DREW  
 Farmer of Fieldhouse/Ballyhea  
 ?? - <1781  
 = ??  
 ?  
 ?? - ??  
 ?

George [William] DREW  
 baker grocer & tallow chandler  
 c1770 - 12 Jun 1818 at Mary St, Lmk  
 = 19 Oct 1797 St Johns, Limerick  
 Sarah RYAN  
 c1775 - 31 Mar 1849 at Munchins  
 St Limerick City

of Limerick City

d of Rev Thomas RYAN BA  
 (TCD) Vicar of Cahircorney LIM  
 1769 - 1807 & Chancellor of  
 Diocese of Emly 1795 - 1807

LC 9 Jan 1822  
 In Mary Street, Mrs DREW, relict of  
 the late Mr. William DREW, baker

merica; piano manufacturer c

iscopal Cemty NY US/

William N DREW  
 born New York State USA  
 c1848 - 1869 d Nagasaki Japan  
 = ??  
 ?  
 ?? - ??  
 ?

Elizabeth DREW  
 Belfast & Seaforde  
 7 Feb 1830 - 12 Nov 1865  
 died unmarried  
 b Broughshane FJ 14 Feb 1830  
 d Seforde, Coleraine Chronicle

Mary Jane DREW  
 Belfast & Seaforde  
 15 Apr 1831 - 1 Dec 1868  
 died unmarried  
 d Dundrum, Cleraine Chron

Catherine DREW  
 Journalist London from 1870's  
 27 May 1832 - 26 Aug 1910  
 died unmarried  
 Foundation member, 1884 & later  
 Vice President Institute of  
 Journalists London

Arminella Frances DREW  
 Belfast & Seaforde  
 18 Jun 1833 - 19 May 1862  
 = 10 Oct 1861 as his 2nd wife  
 William JOHNSTON MP  
 1829 - 1902  
 of Ballykilbeg DOW  
 d s p

Isabella DREW  
 Belfast  
 bpt10 Apr 1835 - 15 Oct 1852  
 died unmarried

Frances Anna DREW  
 ?  
 bpt1 Jun 1836 - ??  
 died an infant

Thomas DREW (Rev)  
 MA DD LLB (TCD)  
 26 Oct 1800 - 22 Oct 1870  
 = 24 Mar 1829 St Marys Dublin  
 Isabella DALTON  
 bpt3 Dec 1802 - 12 May 1869  
 2nd daut of John Keightly  
 DALTON (Dublin Attorney) &  
 Isabella ARMSTRONG

born Limerick City died Dublin  
 Curate Broughshane ANT 1827-33  
 Rector Christchurch Belfast  
 1833-1859 Rector Seaforde DOW  
 1859-1870 Rural Dean &  
 Precentor Down Cathedral  
 His wife was bapt at St Thomas  
 Dublin - died at Seaforde DOW

Mary DREW  
 died at Mary St Limerick City  
 1804 - 20 Jun 1821  
 = ??  
 ?  
 ?? - ??  
 ?

George [L or P or B] DREW  
 died at Nicholas St Limerick  
 1806 - 17 Nov 1834  
 = ??  
 ?  
 ?? - ??  
 ?

Anne DREW  
 of Clonmacken LMK  
 = 8 May 1838 St Marys Cath. Limerick  
 Henry COOKE  
 ?? - ??  
 Classical Teacher at Cathedral Schl.

?? SHELDON  
 Ross, LIM  
 ?? - ??  
 = (1) ??  
 ?  
 ?? - ??  
 = (2) ??  
 Anne ???  
 ?? - ??

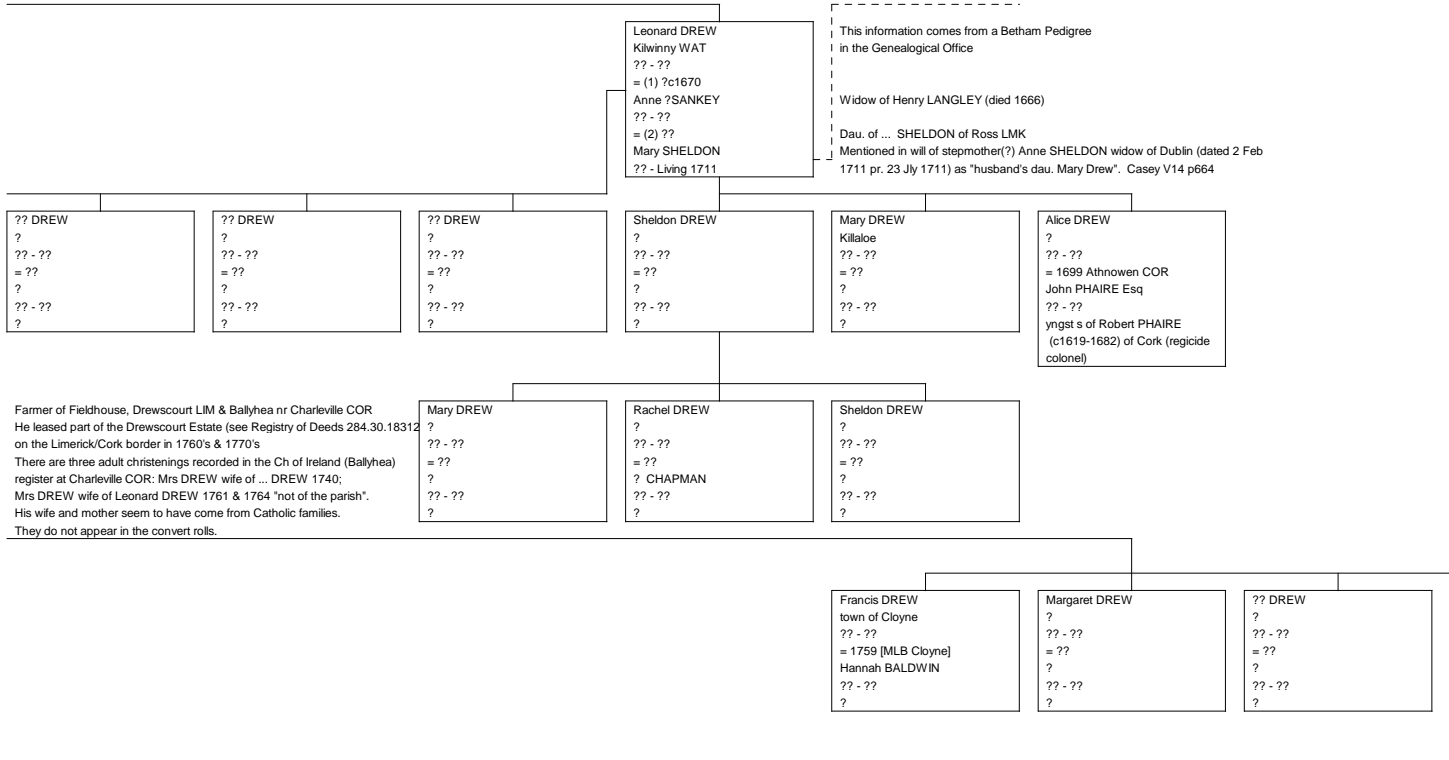

Sarah DREW  
 bpt at St Michaels Limerick City  
 bpt 23 Apr 1814 - ??  
 = ??  
 ?  
 ?? - ??  
 ?

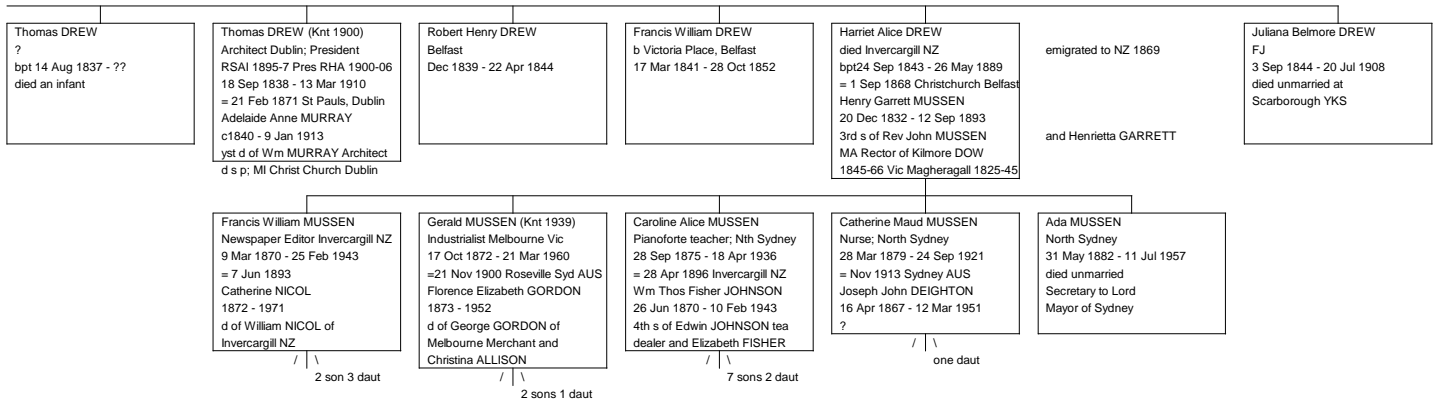

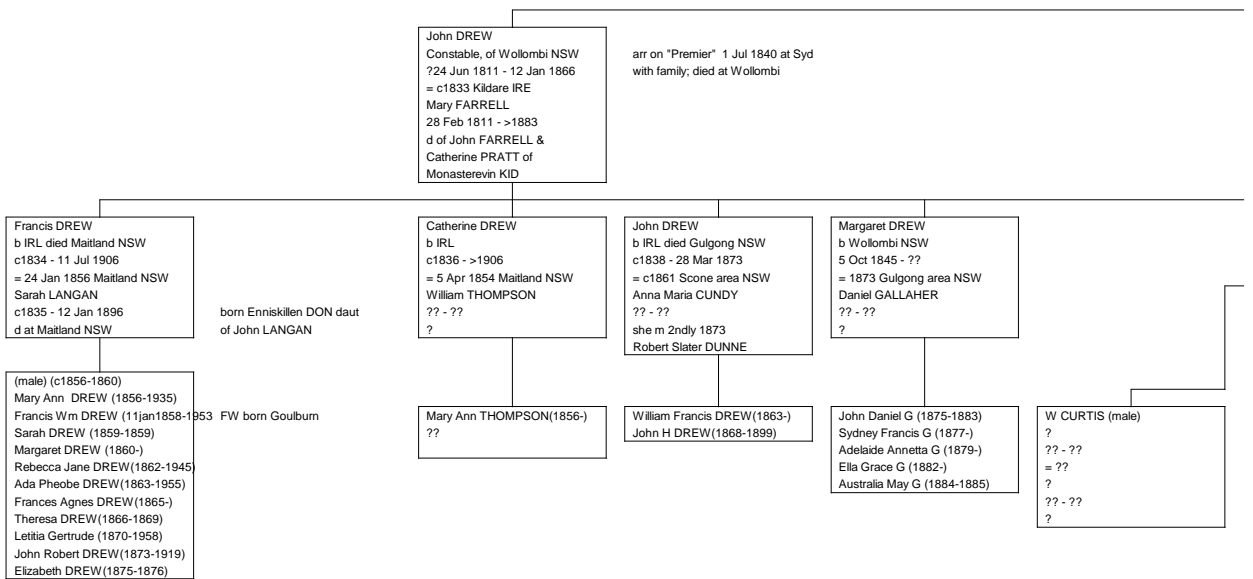
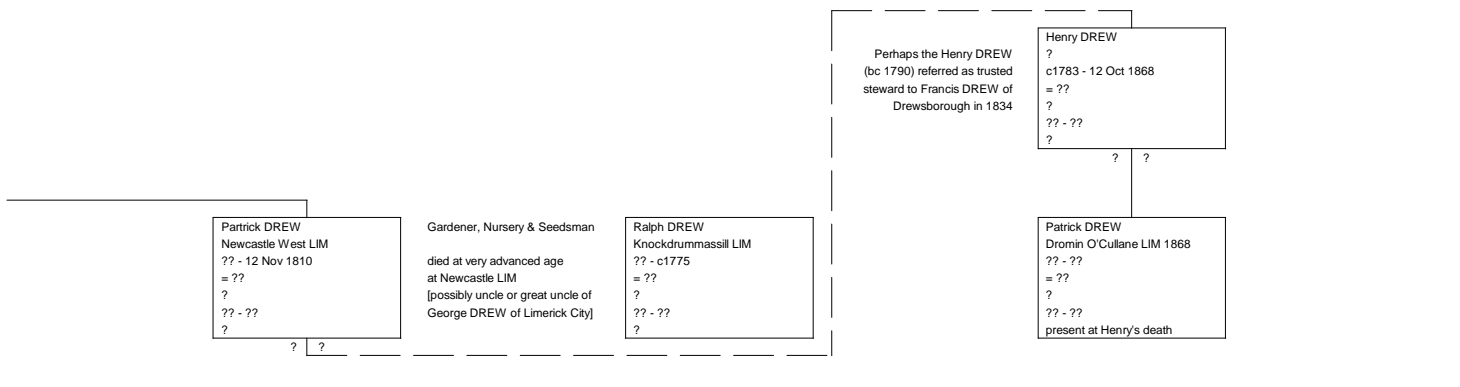

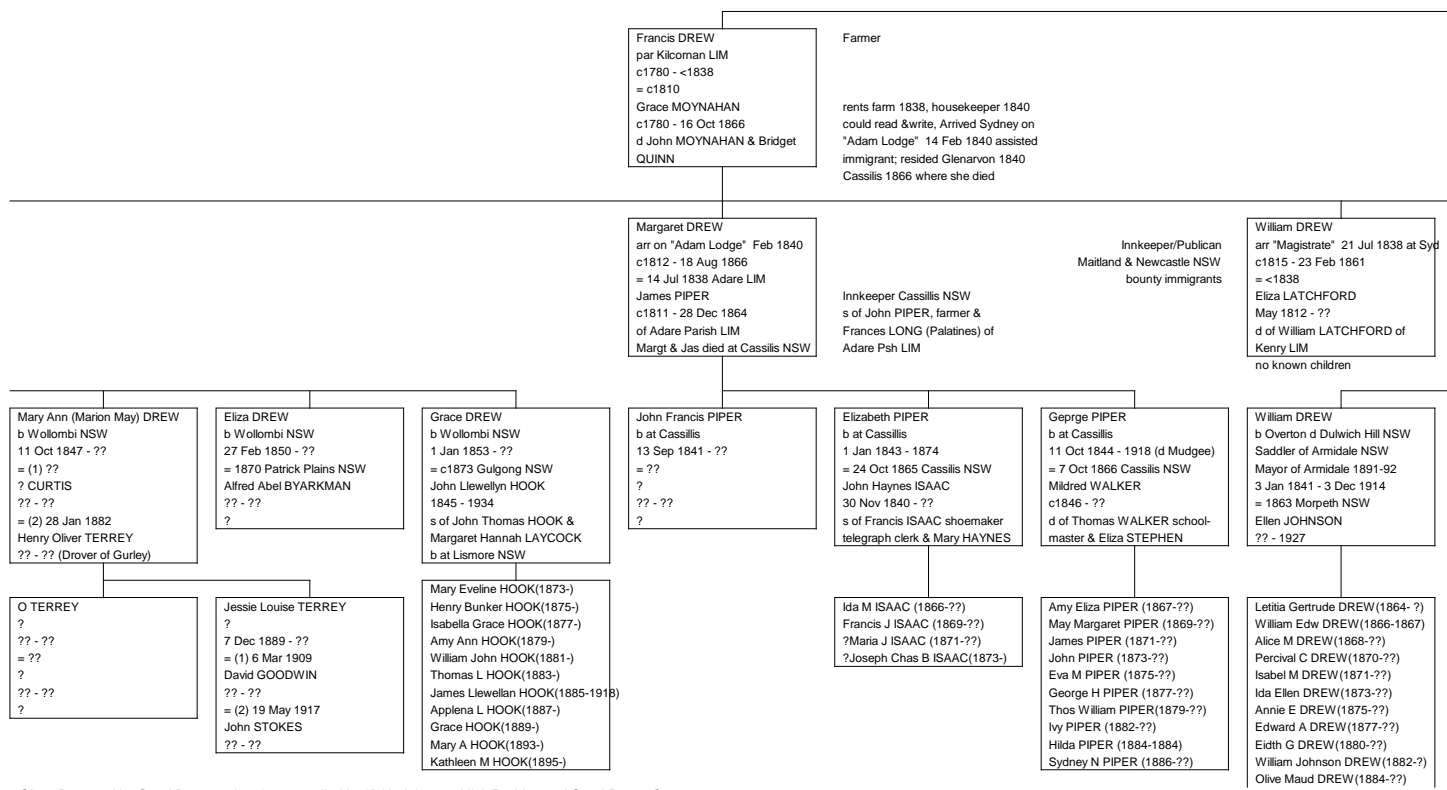

John DREW  
Farmer LIM  
c1750 - ??  
= ??  
Sarah ??  
?? - ??  
?

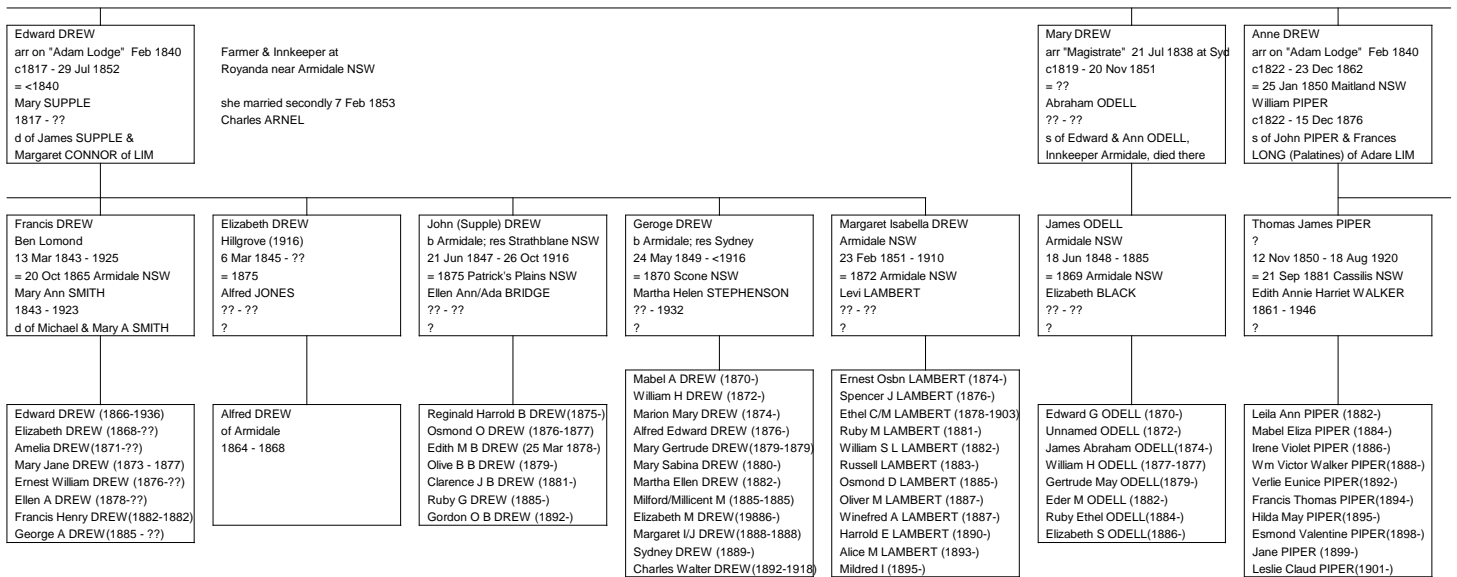



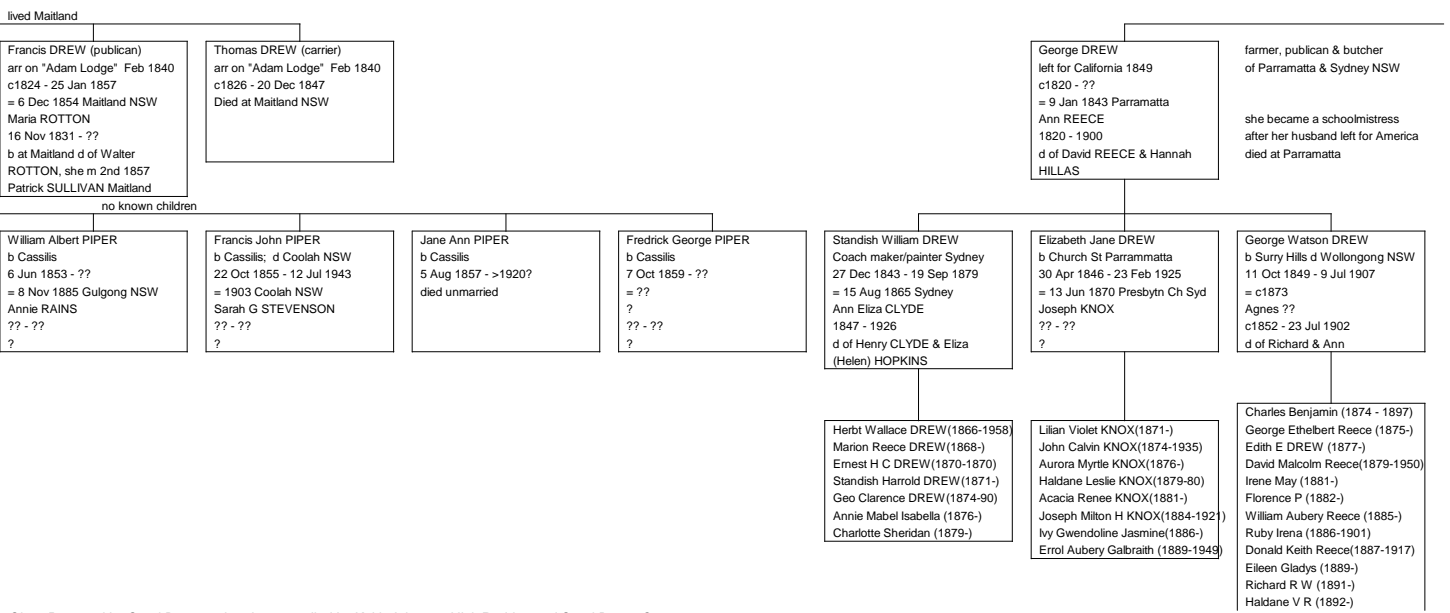

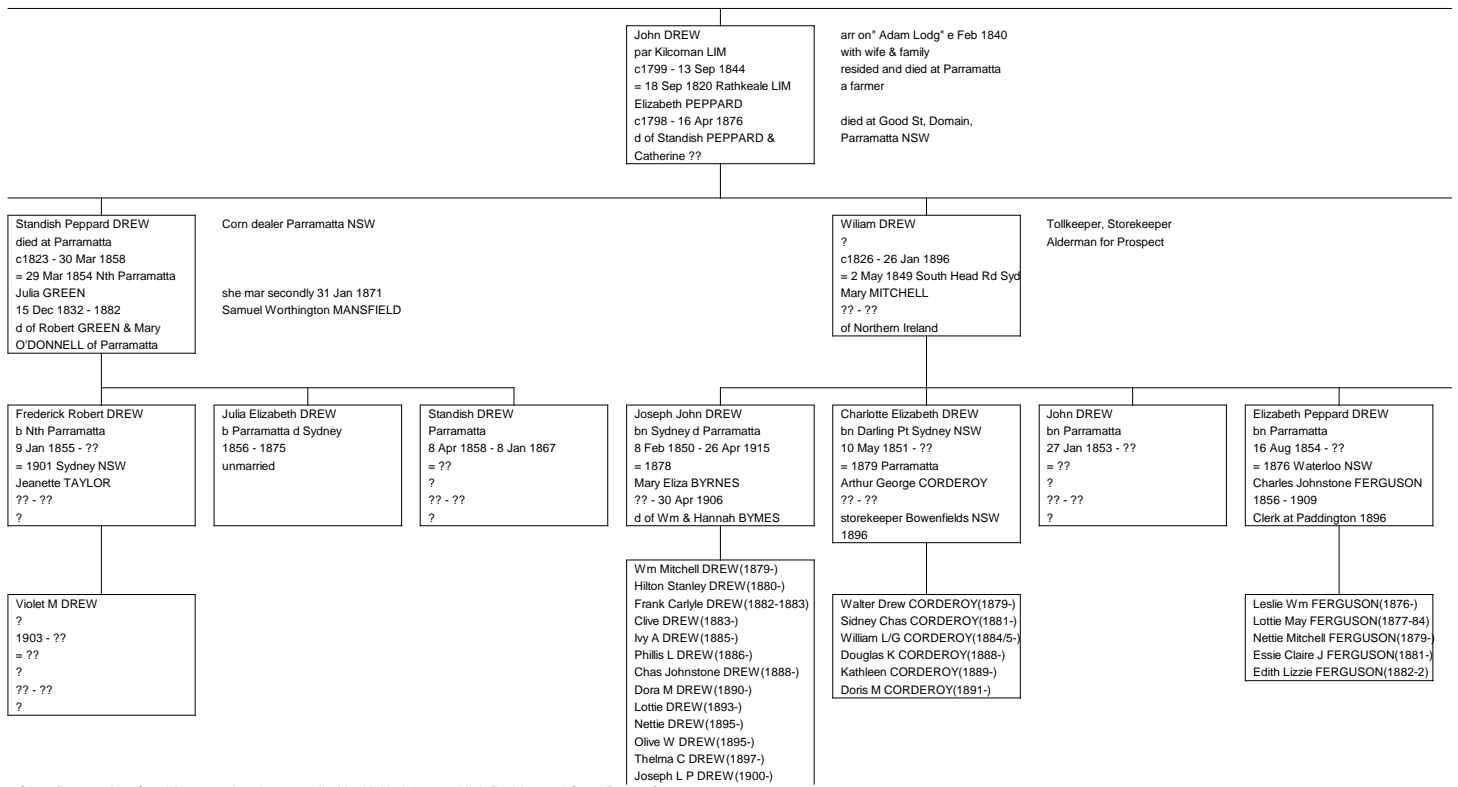

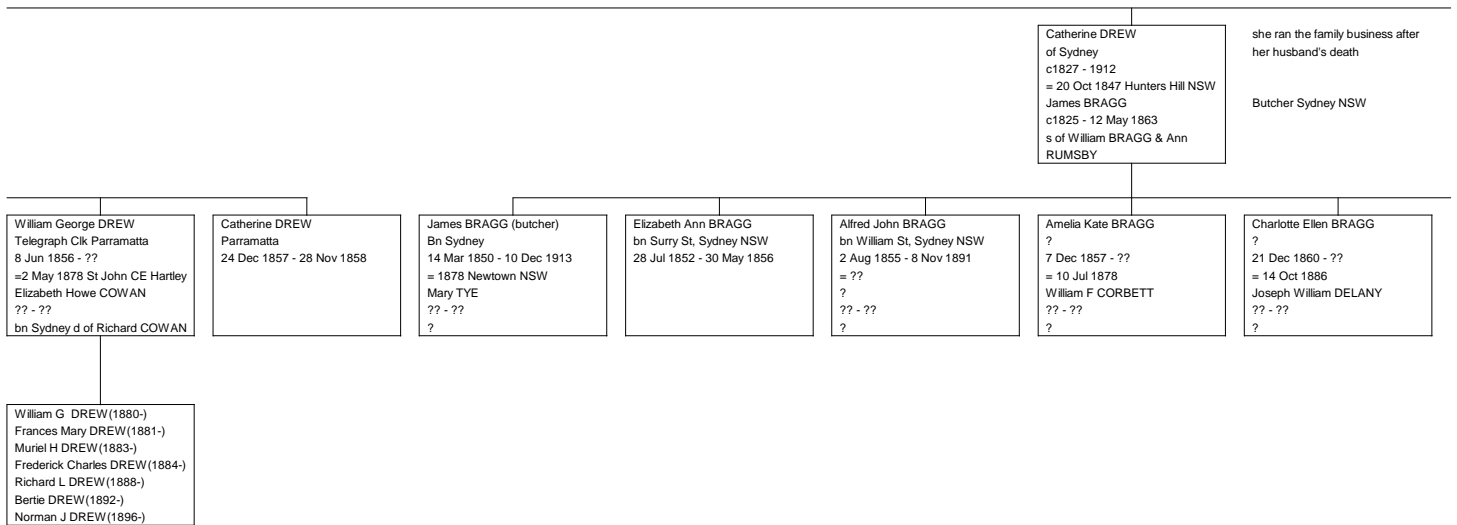

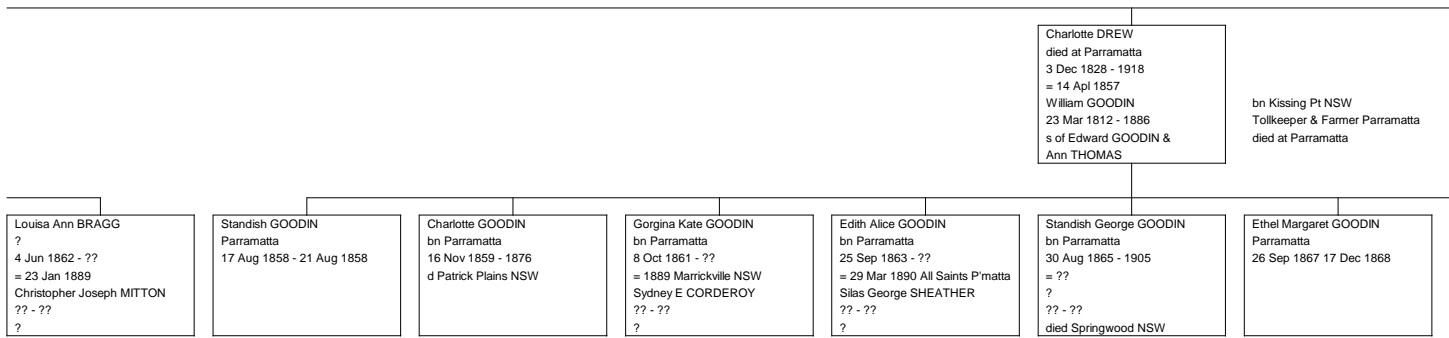

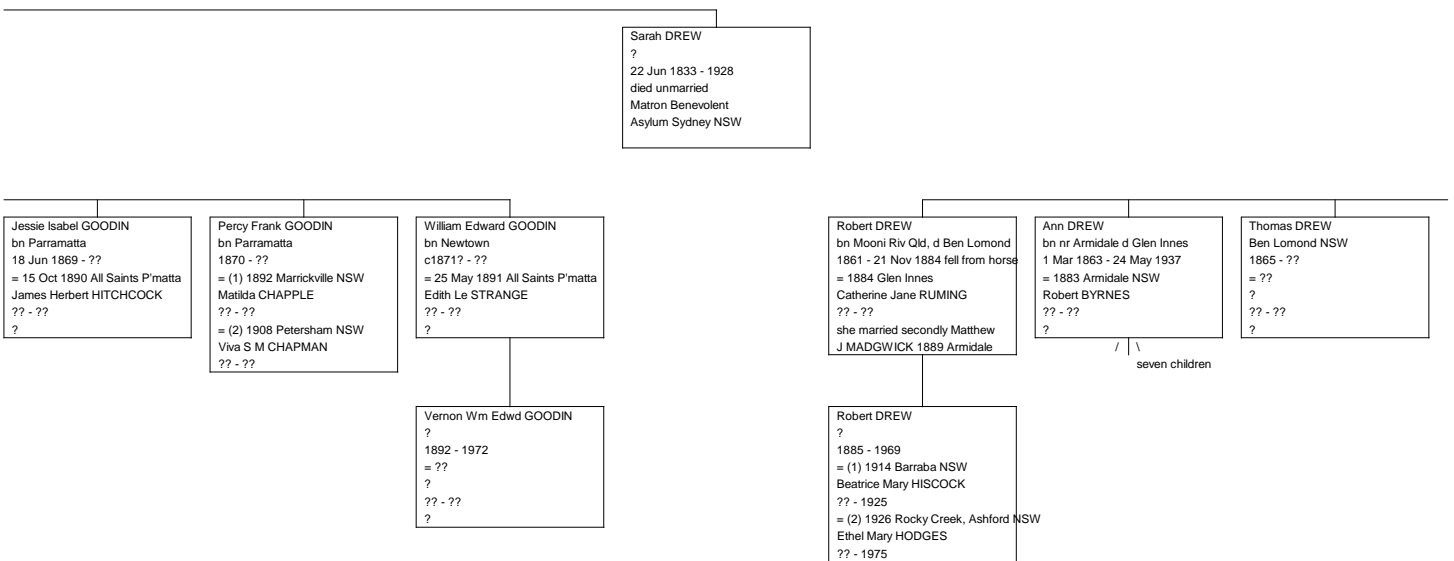

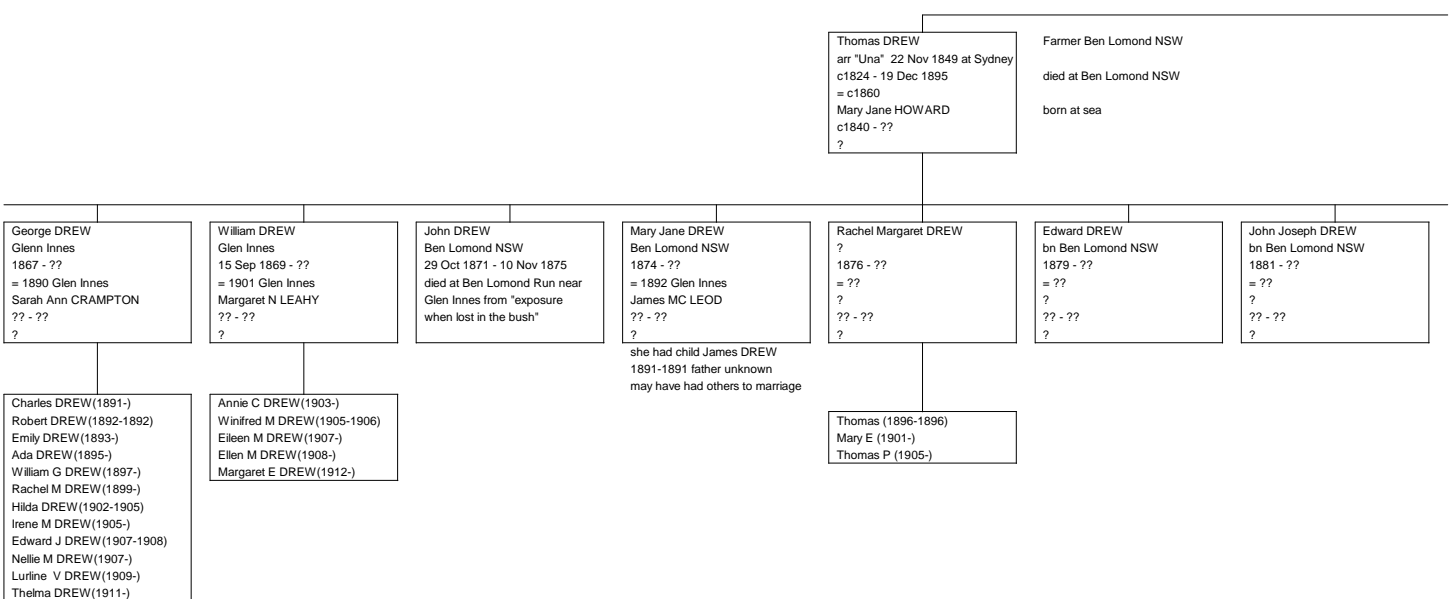

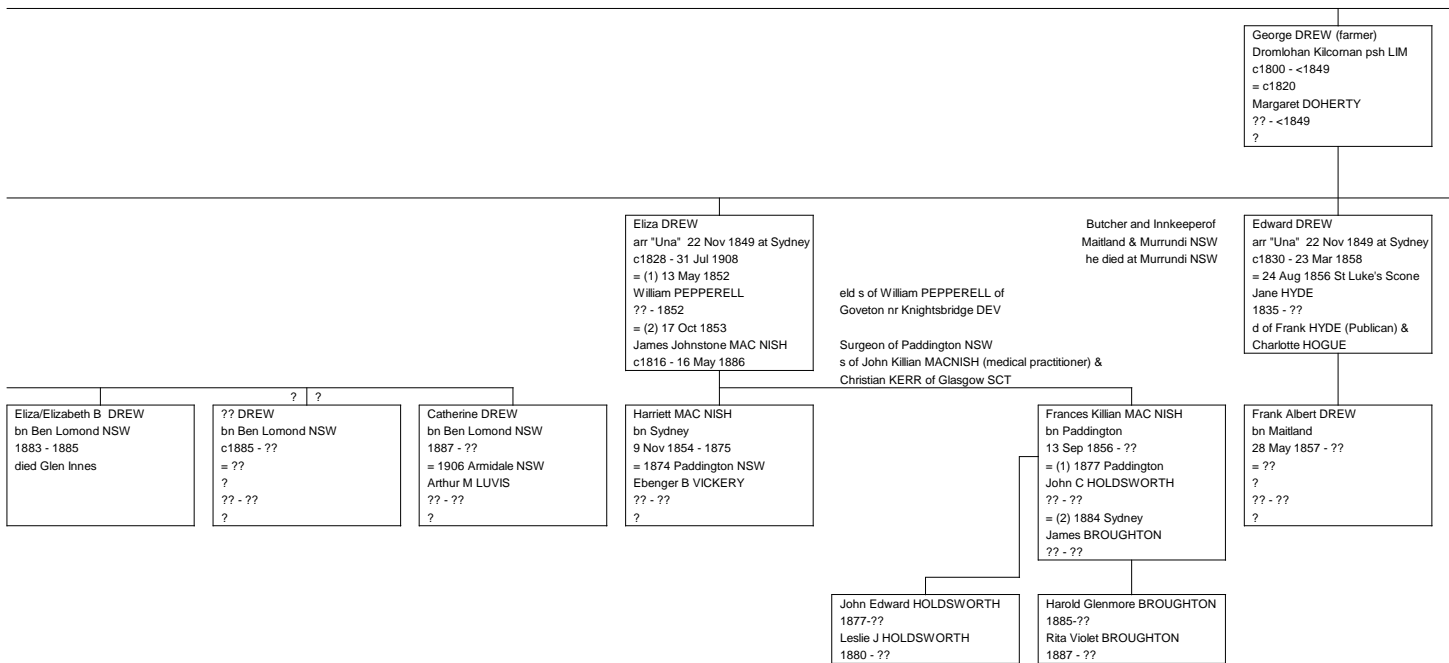

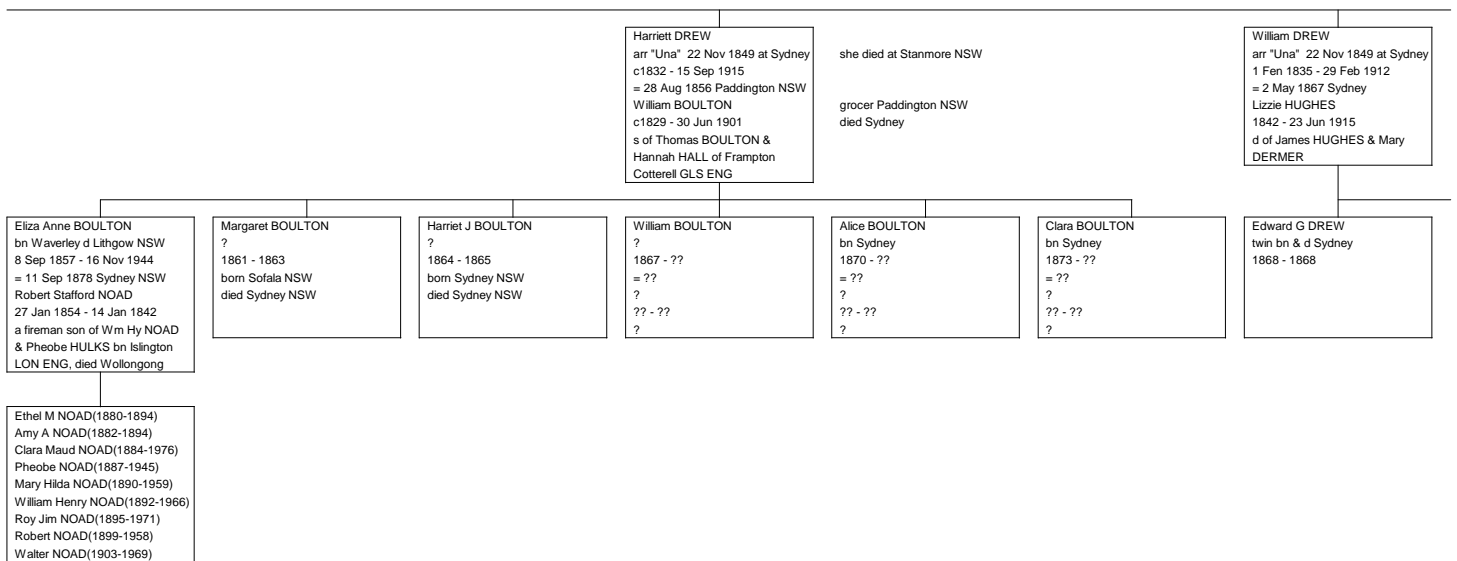



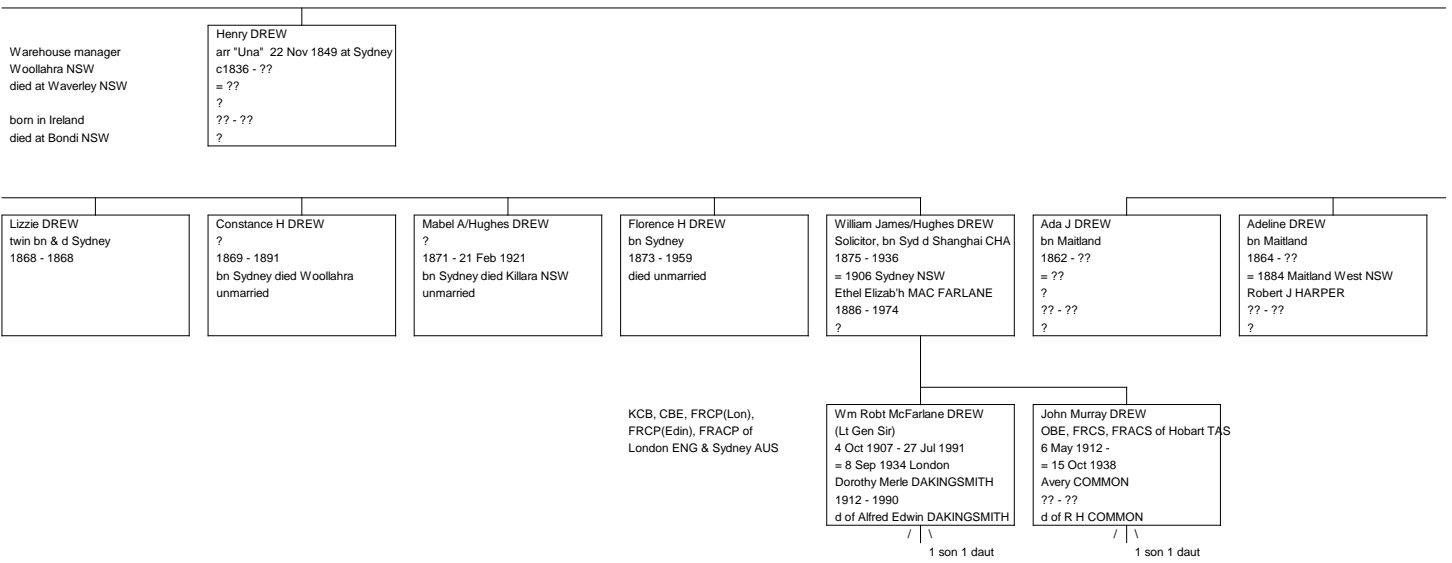

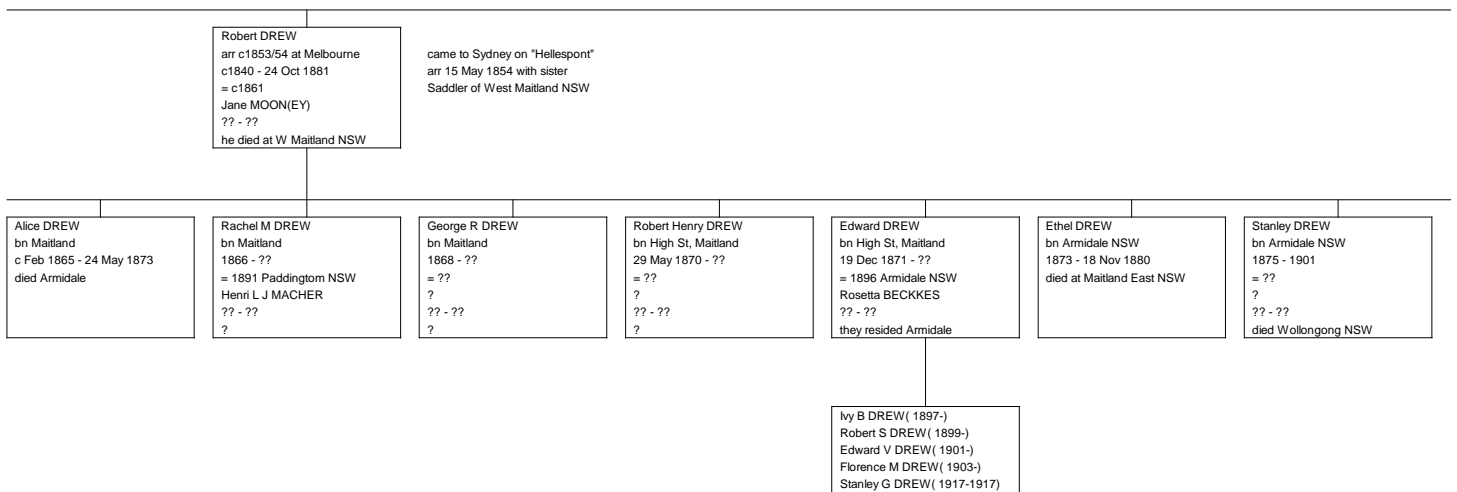

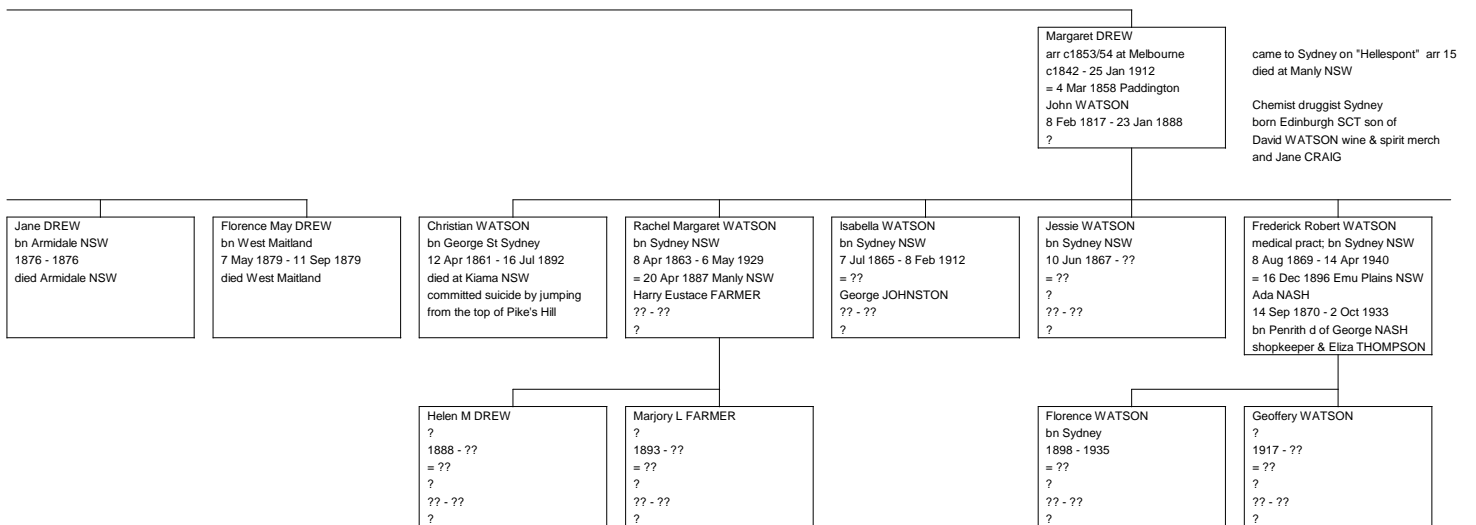

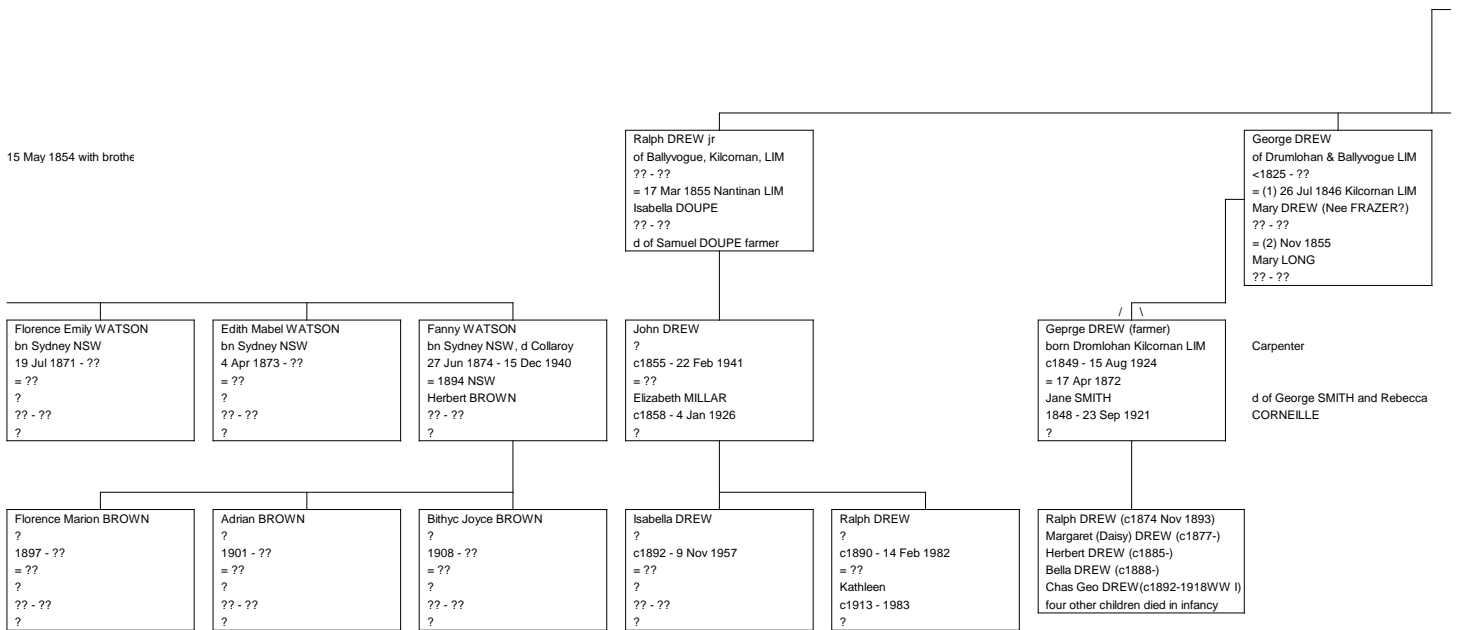

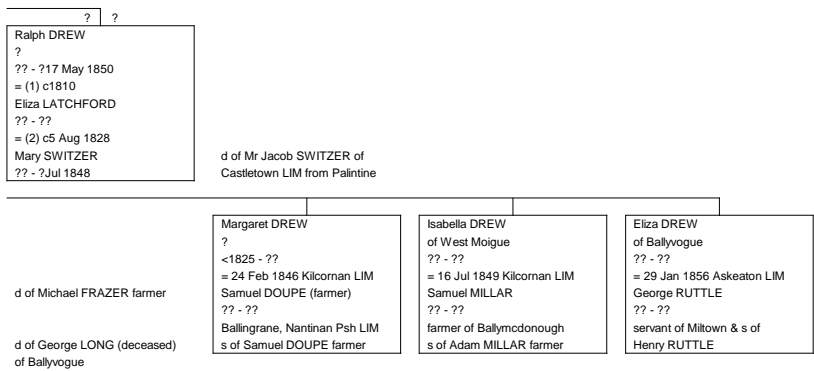
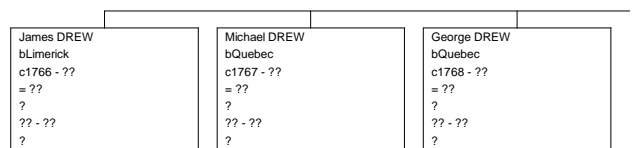

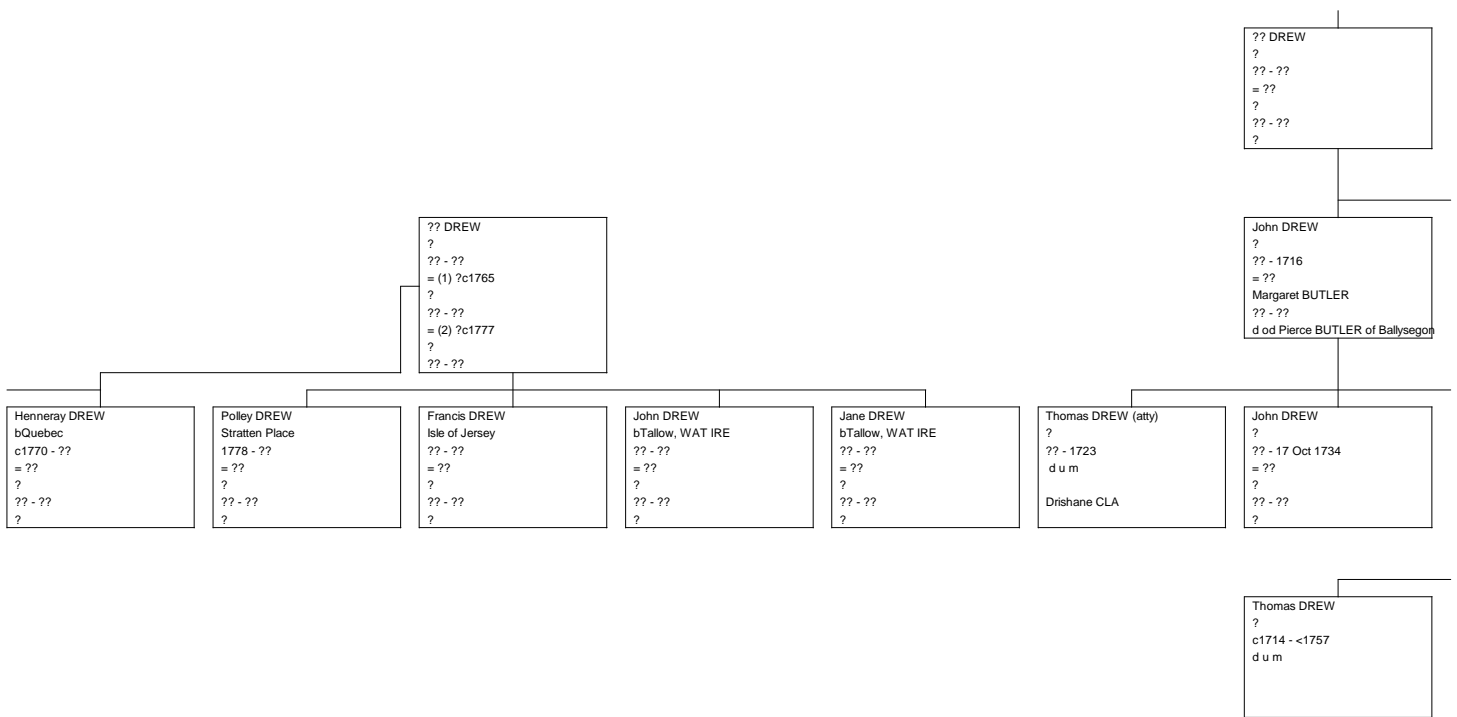

Information in abstract of 10 Dec 1777 Exchequer Bill DREW v BUTLER  
 There were proceedings in the High Court Chancery in 1746  
 See 142.295.95573  
 See 62.531.44019

Thomas DREW  
 Drumcore CLR  
 ?? - <1746  
 d unmarried

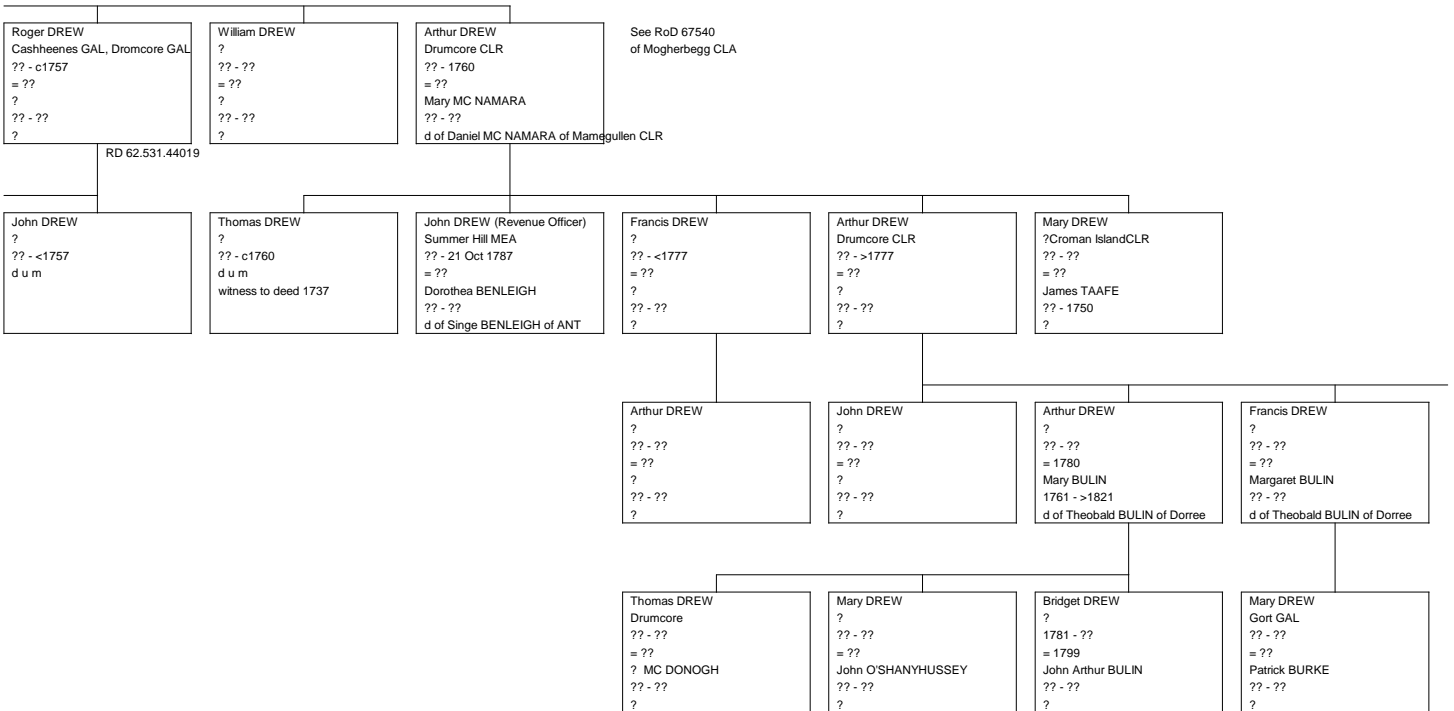

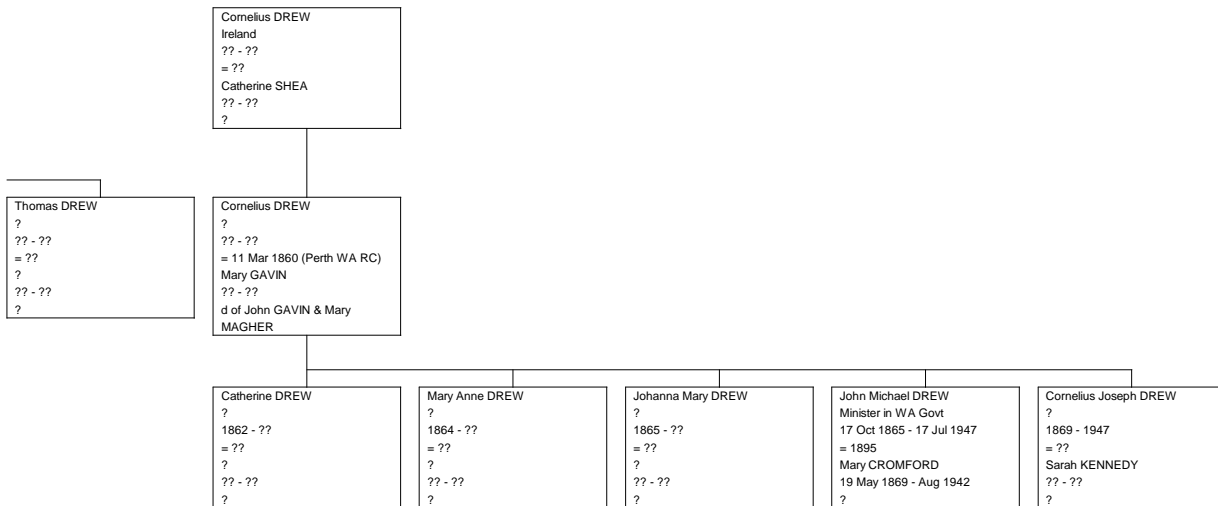



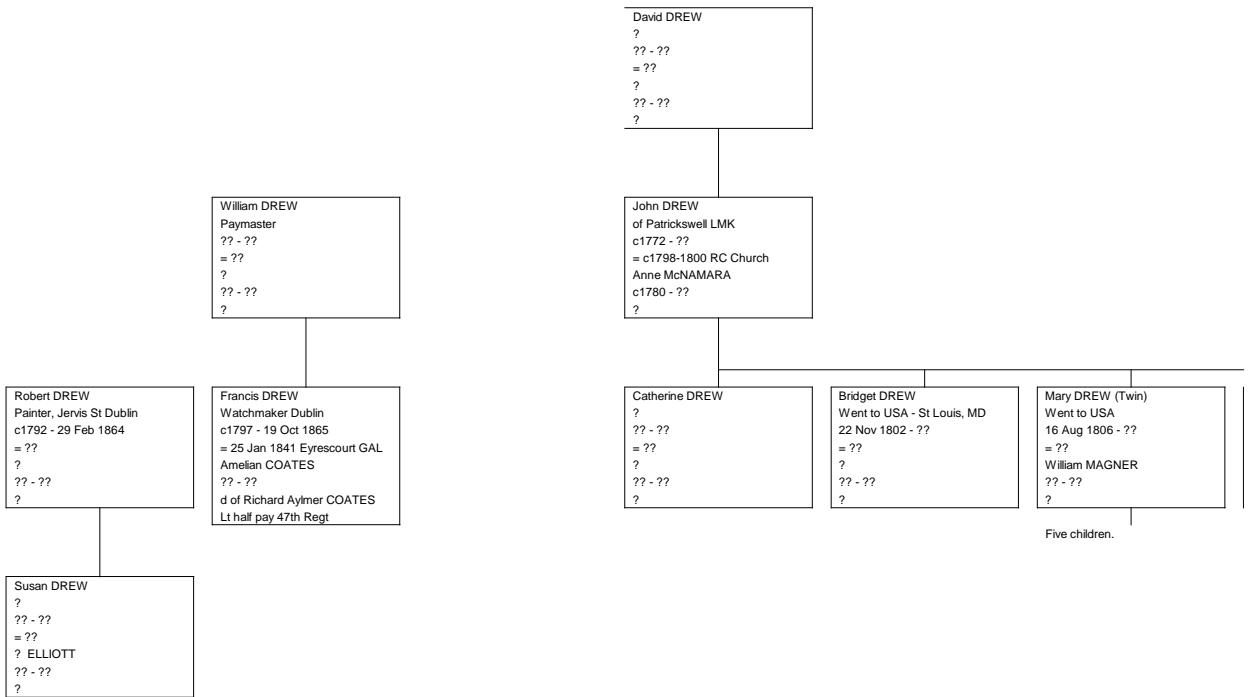

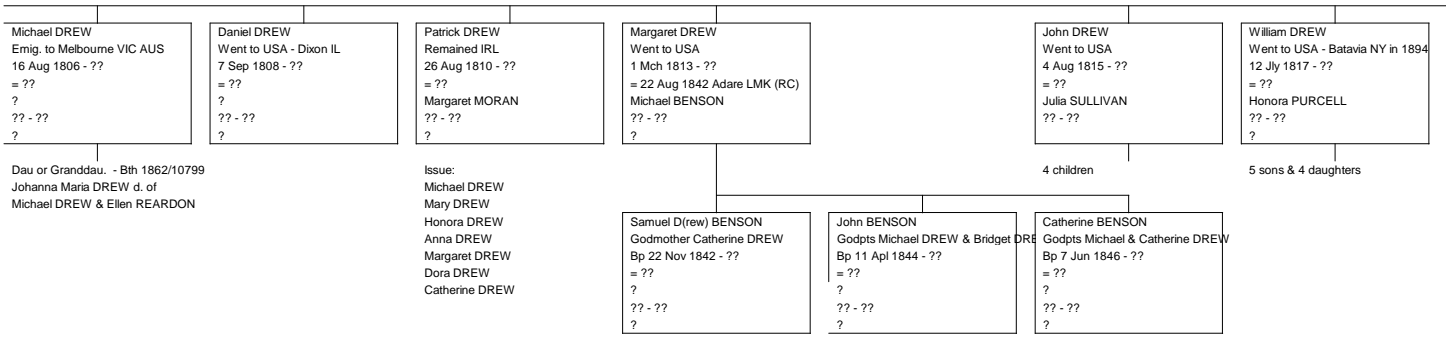

John DREW  
?  
?? - ??  
= ??  
?  
?? - ??  
?

James DREW  
Went to USA - Iowa  
?? - ??  
= ??  
Catherine O'MALLEY  
?? - ??  
Gtgt granddau = Joanna COLLINS

John Ralph DREW  
Artist & Staircase Builder  
1830 - 25 Nov 1919 (aged 89 yrs)  
= (1) c1860 San Francisco CA  
Mary DOWLING  
?? - ??  
= (2) 1868  
Katherine Rice ROCHE  
?? - ??

Bn Kanturk COR; died San Francisco CA.  
Lived with Uncle David DREW in  
Liverpool ENG 1843-1850 when sailed  
to NY. Travelled to SFO via Panama  
in 1856.

Frank C. DREW  
?  
?? - ??  
= ??  
?  
?? - ??  
?

John Sheehan DREW  
(grandfthr of Warren WILKINSON  
Alexandria VA)  
= ??  
?  
?? - ??  
?

William J. DREW  
Principal of Mission High School SFO  
?? - ??  
= ??  
?  
?? - ??  
?

Daniel DREW  
Court Reporter at SFO Hall of Justice  
?? - ??  
= ??  
?  
?? - ??  
?

Eleanor DREW  
Music Teacher for 50 years  
?? - ??  
= ??  
?  
?? - ??  
?

George DREW  
GE Executive  
?? - ??  
= ??  
?  
?? - ??  
?

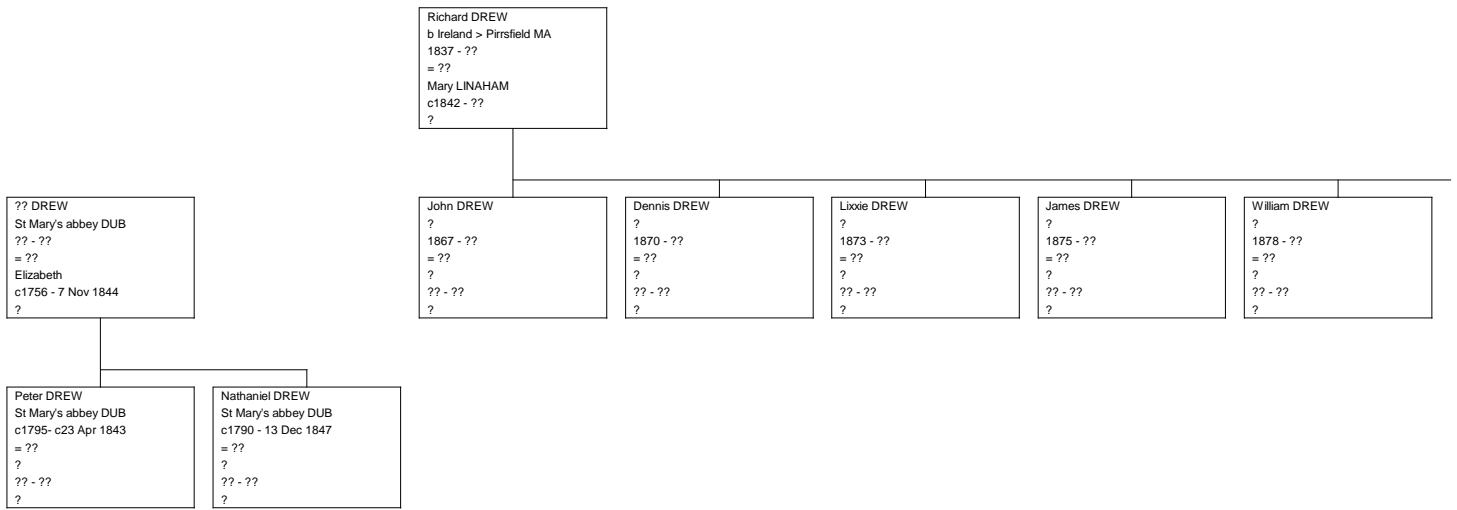

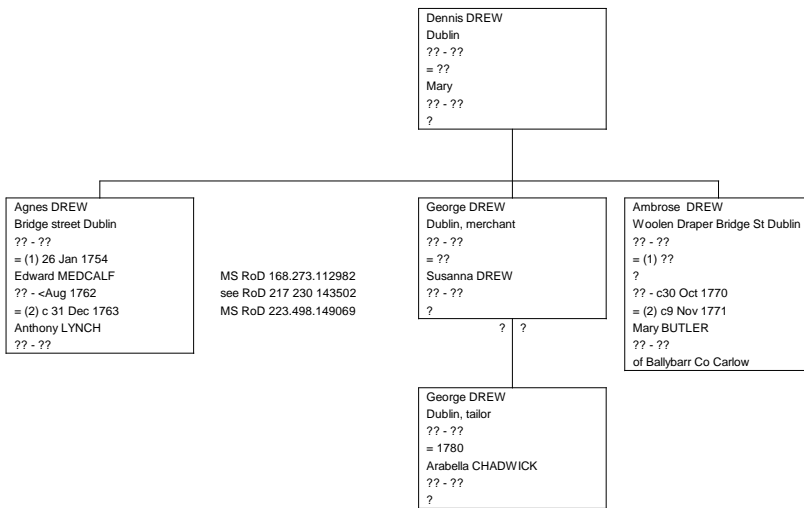

MS RoD 168.273.112982  
see RoD 217.230.143502  
MS RoD 223.498.149069

? ?

Samuel DREW  
?  
1880 - ??  
= ??  
?  
?? - ??  
?